

UIMA Tutorial and Developers' Guides

Written and maintained by the Apache UIMA Development Community

Version 2.3.2-SNAPSHOT

Copyright © 2006, 2010 The Apache Software Foundation

Copyright © 2004, 2006 International Business Machines Corporation

License and Disclaimer. The ASF licenses this documentation to you under the Apache License, Version 2.0 (the "License"); you may not use this documentation except in compliance with the License. You may obtain a copy of the License at

<http://www.apache.org/licenses/LICENSE-2.0>

Unless required by applicable law or agreed to in writing, this documentation and its contents are distributed under the License on an "AS IS" BASIS, WITHOUT WARRANTIES OR CONDITIONS OF ANY KIND, either express or implied. See the License for the specific language governing permissions and limitations under the License.

Trademarks. All terms mentioned in the text that are known to be trademarks or service marks have been appropriately capitalized. Use of such terms in this book should not be regarded as affecting the validity of the the trademark or service mark.

Publication date December, 2010

Table of Contents

1. Annotator & AE Developer's Guide	1
1.1. Getting Started	2
1.1.1. Defining Types	3
1.1.2. Generating Java Source Files for CAS Types	4
1.1.3. Developing Your Annotator Code	5
1.1.4. Creating the XML Descriptor	8
1.1.5. Testing Your Annotator	10
1.2. Configuration and Logging	13
1.2.1. Configuration Parameters	13
1.2.2. Logging	16
1.3. Building Aggregate Analysis Engines	19
1.3.1. Combining Annotators	19
1.3.2. AAEs can also contain CAS Consumers	22
1.3.3. Reading the Results of Previous Annotators	22
1.4. Other examples	24
1.5. Additional Topics	25
1.5.1. Annotator Methods	25
1.5.2. Reporting errors from Annotators	26
1.5.3. Throwing Exceptions from Annotators	27
1.5.4. Accessing External Resource Files	29
1.5.5. Result Specifications	35
1.5.6. Class path setup when using JCas	37
1.5.7. Using the Shell Scripts	37
1.6. Common Pitfalls	38
1.7. UIMA Objects in Eclipse Debugger	39
1.8. Analysis Engine XML Descriptor	39
1.8.1. Header and Annotator Class Identification	40
1.8.2. Simple Metadata Attributes	40
1.8.3. Type System Definition	40
1.8.4. Capabilities	41
1.8.5. Configuration Parameters (Optional)	41
2. CPE Developer's Guide	45
2.1. CPE Concepts	46
2.2. CPE Configurator and CAS viewer	47
2.2.1. Using the CPE Configurator	47
2.2.2. Running the CPE Configurator from Eclipse	51
2.3. Running a CPE from Your Own Java Application	51
2.3.1. Using Listeners	52
2.4. Developing Collection Processing Components	52
2.4.1. Developing Collection Readers	52
2.4.2. Developing CAS Initializers	58
2.4.3. Developing CAS Consumers	58
2.5. Deploying a CPE	60
2.5.1. Deploying Managed CAS Processors	62
2.5.2. Deploying Non-managed CAS Processors	63
2.5.3. Deploying Integrated CAS Processors	64
2.6. Collection Processing Examples	65
3. Application Developer's Guide	67
3.1. The UIMAFramework Class	67
3.2. Using Analysis Engines	67
3.2.1. Instantiating an Analysis Engine	68

3.2.2. Analyzing Text Documents	68
3.2.3. Analyzing Non-Text Artifacts	69
3.2.4. Accessing Analysis Results	69
3.2.5. Multi-threaded Applications	70
3.2.6. Multiple AEs & Creating Shared CASes	72
3.2.7. Saving CASes to file systems	73
3.3. Using Collection Processing Engines	73
3.3.1. Running a CPE from a Descriptor	73
3.3.2. Configuring a CPE Descriptor Programmatically	73
3.4. Setting Configuration Parameters	76
3.5. Integrating Text Analysis and Search	77
3.5.1. Building an Index	77
3.5.2. Semantic Search Query Tool	80
3.6. Working with Remote Services	81
3.6.1. Deploying as SOAP Service	81
3.6.2. Deploying as a Vinci Service	83
3.6.3. Calling a UIMA Service	84
3.6.4. Restrictions on remotely deployed services	86
3.6.5. The Vinci Naming Services (VNS)	86
3.6.6. Configuring Timeout Settings	88
3.7. Increasing performance using parallelism	90
3.8. Monitoring AE Performance using JMX	91
3.9. Performance Tuning Options	93
4. Flow Controller Developer's Guide	95
4.1. Developing the Flow Controller Code	95
4.1.1. Flow Controller Interface Overview	95
4.1.2. Example Code	96
4.2. Creating the Flow Controller Descriptor	98
4.3. Adding Flow Controller to an Aggregate	99
4.4. Adding Flow Controller to CPE	100
4.5. Using Flow Controllers with CAS Multipliers	100
4.6. Continuing the Flow When Exceptions Occur	101
5. Annotations, Artifacts & Sofas	103
5.1. Terminology	103
5.1.1. Artifact	103
5.1.2. Subject of Analysis — Sofa	103
5.2. Formats of Sofa Data	103
5.3. Setting and Accessing Sofa Data	104
5.3.1. Setting Sofa Data	104
5.3.2. Accessing Sofa Data	104
5.3.3. Accessing Sofa Data using a Java Stream	104
5.4. The Sofa Feature Structure	105
5.5. Annotations	105
5.5.1. Built-in Annotation types	105
5.5.2. Annotations have an associated Sofa	106
5.6. AnnotationBase	106
6. Multiple CAS Views	107
6.1. CAS Views and Sofas	107
6.1.1. Naming CAS Views and Sofas	107
6.1.2. Multi/Single View parts in Applications	108
6.2. Multi-View Components	108
6.2.1. Deciding: Multi-View	108
6.2.2. Multi-View: additional capabilities	108

6.2.3. Component XML metadata	108
6.3. Sofa Capabilities & APIs for Apps	109
6.4. Sofa Name Mapping	109
6.4.1. Name Mapping in an Aggregate Descriptor	110
6.4.2. Name Mapping in a CPE Descriptor	110
6.4.3. CAS View for Single-View Parts	111
6.4.4. Name Mapping in a UIMA Application	111
6.4.5. Name Mapping for Remote Services	112
6.5. JCas extensions for Multiple Views	112
6.6. Sample Multi-View Application	113
6.6.1. Annotator Descriptor	113
6.6.2. Application Setup	113
6.6.3. Annotator Processing	114
6.6.4. Accessing the results of analysis	114
6.7. Views API Summary	115
6.8. Sofa Incompatibilities: V1 and V2	116
7. CAS Multiplier	117
7.1. Developing the CAS Multiplier Code	117
7.1.1. CAS Multiplier Interface Overview	117
7.1.2. Getting an empty CAS Instance	118
7.1.3. Example Code	118
7.2. CAS Multiplier Descriptor	121
7.3. Using CAS Multipliers in Aggregates	122
7.3.1. Aggregate: Adding the CAS Multiplier	122
7.3.2. CAS Multipliers and Flow Control	123
7.3.3. Aggregate CAS Multipliers	124
7.4. CAS Multipliers in CPE's	125
7.5. Applications: Calling CAS Multipliers	125
7.5.1. Output CASes	125
7.5.2. CAS Multipliers with other AEs	126
7.6. Merging with CAS Multipliers	127
7.6.1. CAS Merging Overview	127
7.6.2. Example CAS Merger	127
7.6.3. SimpleTextMerger in an Aggregate	129
8. XMI & EMF	131
8.1. Overview	131
8.2. Converting an Ecore Model to or from a UIMA Type System	131
8.3. Using XMI CAS Serialization	132
8.3.1. Character Encoding Issues with XML Serialization	132

Chapter 1. Annotator and Analysis Engine Developer's Guide

This chapter describes how to develop UIMA *type systems*, *Annotators* and *Analysis Engines* using the UIMA SDK. It is helpful to read the UIMA Conceptual Overview chapter for a review on these concepts.

An *Analysis Engine (AE)* is a program that analyzes artifacts (e.g. documents) and infers information from them.

Analysis Engines are constructed from building blocks called *Annotators*. An annotator is a component that contains analysis logic. Annotators analyze an artifact (for example, a text document) and create additional data (metadata) about that artifact. It is a goal of UIMA that annotators need not be concerned with anything other than their analysis logic – for example the details of their deployment or their interaction with other annotators.

An Analysis Engine (AE) may contain a single annotator (this is referred to as a *Primitive AE*), or it may be a composition of others and therefore contain multiple annotators (this is referred to as an *Aggregate AE*). Primitive and aggregate AEs implement the same interface and can be used interchangeably by applications.

Annotators produce their analysis results in the form of typed *Feature Structures*, which are simply data structures that have a type and a set of (attribute, value) pairs. An *annotation* is a particular type of Feature Structure that is attached to a region of the artifact being analyzed (a span of text in a document, for example).

For example, an annotator may produce an Annotation over the span of text `President Bush`, where the type of the Annotation is `Person` and the attribute `fullName` has the value `George W. Bush`, and its position in the artifact is character position 12 through character position 26.

It is also possible for annotators to record information associated with the entire document rather than a particular span (these are considered Feature Structures but not Annotations).

All feature structures, including annotations, are represented in the UIMA *Common Analysis Structure(CAS)*. The CAS is the central data structure through which all UIMA components communicate. Included with the UIMA SDK is an easy-to-use, native Java interface to the CAS called the *JCas*. The JCas represents each feature structure as a Java object; the example feature structure from the previous paragraph would be an instance of a Java class `Person` with `getFullName()` and `setFullName()` methods. Though the examples in this guide all use the JCas, it is also possible to directly access the underlying CAS system; for more information see Chapter 4, *CAS Reference* .

The remainder of this chapter will refer to the analysis of text documents and the creation of annotations that are attached to spans of text in those documents. Keep in mind that the CAS can represent arbitrary types of feature structures, and feature structures can refer to other feature structures. For example, you can use the CAS to represent a parse tree for a document. Also, the artifact that you are analyzing need not be a text document.

This guide is organized as follows:

- **Section 1.1, “Getting Started” [2]** is a tutorial with step-by-step instructions for how to develop and test a simple UIMA annotator.

- [Section 1.2, “Configuration and Logging” \[13\]](#) discusses how to make your UIMA annotator configurable, and how it can write messages to the UIMA log file.
- [Section 1.3, “Building Aggregate Analysis Engines” \[19\]](#) describes how annotators can be combined into aggregate analysis engines. It also describes how one annotator can make use of the analysis results produced by an annotator that has run previously.
- [Section 1.4, “Other examples” \[24\]](#) describes several other examples you may find interesting, including
 - SimpleTokenAndSentenceAnnotator – a simple tokenizer and sentence annotator.
 - PersonTitleDBWriterCasConsumer – a sample CAS Consumer which populates a relational database with some annotations. It uses JDBC and in this example, hooks up with the Open Source Apache Derby database.
- [Section 1.5, “Additional Topics” \[25\]](#) describes additional features of the UIMA SDK that may help you in building your own annotators and analysis engines.
- [Section 1.6, “Common Pitfalls” \[38\]](#) contains some useful guidelines to help you ensure that your annotators will work correctly in any UIMA application.

This guide does not discuss how to build UIMA Applications, which are programs that use Analysis Engines, along with other components, e.g. a search engine, document store, and user interface, to deliver a complete package of functionality to an end-user. For information on application development, see Chapter 3: “” .

1.1. Getting Started

This section is a step-by-step tutorial that will get you started developing UIMA annotators. All of the files referred to by the examples in this chapter are in the `examples` directory of the UIMA SDK. This directory is designed to be imported into your Eclipse workspace; see Section 3.2, “Setting up Eclipse to view Example Code” for instructions on how to do this. See Section 3.4, “Attaching UIMA Javadocs” for how to attach the UIMA Javadocs to the jar files. Also you may wish to refer to the UIMA SDK Javadocs located in the [docs/api/index.html](#)¹ directory.

Note: In Eclipse 3.1, if you highlight a UIMA class or method defined in the UIMA SDK Javadocs, you can conveniently have Eclipse open the corresponding Javadoc for that class or method in a browser, by pressing Shift + F2.

Note: If you downloaded the source distribution for UIMA, you can attach that as well to the library Jar files; for information on how to do this, see Chapter 1, *Javadocs*.

The example annotator that we are going to walk through will detect room numbers for rooms where the room numbering scheme follows some simple conventions. In our example, there are two kinds of patterns we want to find; here are some examples, together with their corresponding regular expression patterns:

Yorktown patterns:

20-001, 31-206, 04-123 (Regular Expression Pattern: `##-[0-2]##`)

Hawthorne patterns:

GN-K35, 1S-L07, 4N-B21 (Regular Expression Pattern: `[G1-4][NS]-[A-Z]##`)

There are several steps to develop and test a simple UIMA annotator.

¹ [api/index.html](#)

1. Define the CAS types that the annotator will use.
2. Generate the Java classes for these types.
3. Write the actual annotator Java code.
4. Create the Analysis Engine descriptor.
5. Test the annotator.

These steps are discussed in the next sections.

1.1.1. Defining Types

The first step in developing an annotator is to define the CAS Feature Structure types that it creates. This is done in an XML file called a *Type System Descriptor*. UIMA defines basic primitive types such as Boolean, Byte, Short, Integer, Long, Float, and Double, as well as Arrays of these primitive types. UIMA also defines the built-in types TOP, which is the root of the type system, analogous to Object in Java; FSArray, which is an array of Feature Structures (i.e. an array of instances of TOP); and Annotation, which we will discuss in more detail in this section.

UIMA includes an Eclipse plug-in that will help you edit Type System Descriptors, so if you are using Eclipse you will not need to worry about the details of the XML syntax. See Chapter 3, *Setting up the Eclipse IDE to work with UIMA* for instructions on setting up Eclipse and installing the plugin.

The Type System Descriptor for our annotator is located in the file `descriptors/tutorial/ex1/TutorialTypeSystem.xml`. (This and all other examples are located in the `examples` directory of the installation of the UIMA SDK, which can be imported into an Eclipse project for your convenience, as described in Section 3.2, “Setting up Eclipse to view Example Code”.)

In Eclipse, expand the `uima-j-examples` project in the Package Explorer view, and browse to the file `descriptors/tutorial/ex1/TutorialTypeSystem.xml`. Right-click on the file in the navigator and select `Open With` → `Component Descriptor Editor`. Once the editor opens, click on the “Type System” tab at the bottom of the editor window. You should see a view such as the following:

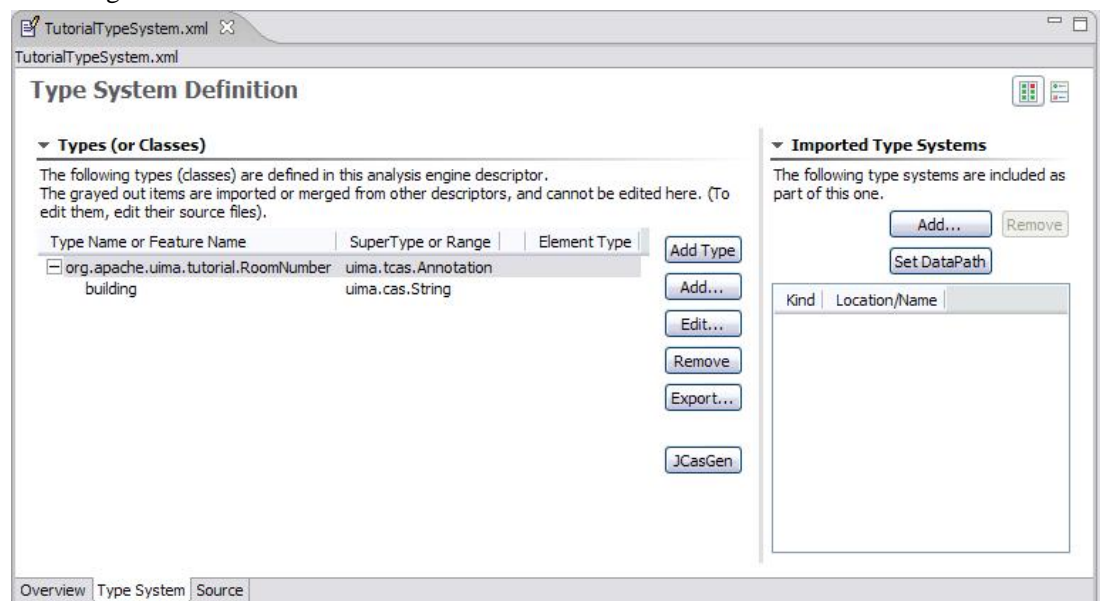

Our annotator will need only one type – `org.apache.uima.tutorial.RoomNumber`. (We use the same namespace conventions as are used for Java classes.) Just as in Java, types have

supertypes. The supertype is listed in the second column of the left table. In this case our RoomNumber annotation extends from the built-in type `uima.tcas.Annotation`.

Descriptions can be included with types and features. In this example, there is a description associated with the `building` feature. To see it, hover the mouse over the feature.

The bottom tab labeled “Source” will show you the XML source file associated with this descriptor.

The built-in Annotation type declares three fields (called *Features* in CAS terminology). The features `begin` and `end` store the character offsets of the span of text to which the annotation refers. The feature `sofa` (Subject of Analysis) indicates which document the begin and end offsets point into. The `sofa` feature can be ignored for now since we assume in this tutorial that the CAS contains only one subject of analysis (document).

Our RoomNumber type will inherit these three features from `uima.tcas.Annotation`, its supertype; they are not visible in this view because inherited features are not shown. One additional feature, `building`, is declared. It takes a String as its value. Instead of String, we could have declared the range-type of our feature to be any other CAS type (defined or built-in).

If you are not using Eclipse, if you need to edit the type system, do so using any XML or text editor, directly. The following is the actual XML representation of the Type System displayed above in the editor:

```
<?xml version="1.0" encoding="UTF-8" ?>
<typeSystemDescription xmlns="http://uima.apache.org/resourceSpecifier">
  <name>TutorialTypeSystem</name>
  <description>Type System Definition for the tutorial examples -
    as of Exercise 1</description>
  <vendor>Apache Software Foundation</vendor>
  <version>1.0</version>
  <types>
    <typeDescription>
      <name>org.apache.uima.tutorial.RoomNumber</name>
      <description></description>
      <supertypeName>uima.tcas.Annotation</supertypeName>
      <features>
        <featureDescription>
          <name>building</name>
          <description>Building containing this room</description>
          <rangeTypeName>uima.cas.String</rangeTypeName>
        </featureDescription>
      </features>
    </typeDescription>
  </types>
</typeSystemDescription>
```

1.1.2. Generating Java Source Files for CAS Types

When you save a descriptor that you have modified, the Component Descriptor Editor will automatically generate Java classes corresponding to the types that are defined in that descriptor (unless this has been disabled), using a utility called JCasGen. These Java classes will have the same name (including package) as the CAS types, and will have get and set methods for each of the features that you have defined.

This feature is enabled/disabled using the UIMA menu pulldown (or the Eclipse Preferences → UIMA). If automatic running of JCasGen is not happening, please make sure the option is checked:

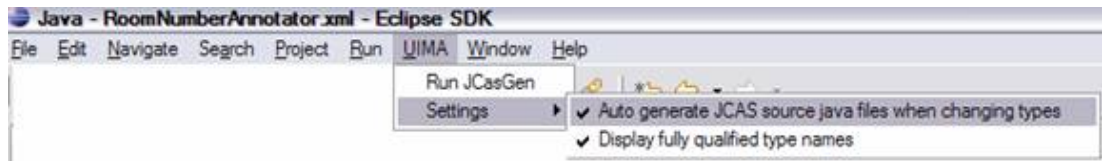

The Java class for the example `org.apache.uima.tutorial.RoomNumber` type can be found in `src/org/apache/uima/tutorial/RoomNumber.java`. You will see how to use these generated classes in the next section.

If you are not using the Component Descriptor Editor, you will need to generate these Java classes by using the *JCasGen* tool. *JCasGen* reads a Type System Descriptor XML file and generates the corresponding Java classes that you can then use in your annotator code. To launch *JCasGen*, run the `jasgen` shell script located in the `/bin` directory of the UIMA SDK installation. This should launch a GUI that looks something like this:



Use the “Browse” buttons to select your input file (`TutorialTypeSystem.xml`) and output directory (the root of the source tree into which you want the generated files placed). Then click the “Go” button. If the Type System Descriptor has no errors, new Java source files will be generated under the specified output directory.

There are some additional options to choose from when running *JCasGen*; please refer to the Chapter 7, *JCasGen User's Guide* for details.

1.1.3. Developing Your Annotator Code

Annotator implementations all implement a standard interface (`AnalysisComponent`), having several methods, the most important of which are:

- `initialize`,
- `process`, and
- `destroy`.

`initialize` is called by the framework once when it first creates an instance of the annotator class. `process` is called once per item being processed. `destroy` may be called by the application when it is done using your annotator. There is a default implementation of this interface for

annotators using the JCas, called `JCasAnnotator_ImplBase`, which has implementations of all required methods except for the process method.

Our annotator class extends the `JCasAnnotator_ImplBase`; most annotators that use the JCas will extend from this class, so they only have to implement the process method. This class is not restricted to handling just text; see Chapter 5, *Annotations, Artifacts, and Sofas*.

Annotators are not required to extend from the `JCasAnnotator_ImplBase` class; they may instead directly implement the `AnalysisComponent` interface, and provide all method implementations themselves.² This allows you to have your annotator inherit from some other superclass if necessary. If you would like to do this, see the Javadocs for `JCasAnnotator` for descriptions of the methods you must implement.

Annotator classes need to be public, cannot be declared abstract, and must have public, 0-argument constructors, so that they can be instantiated by the framework.³

The class definition for our `RoomNumberAnnotator` implements the process method, and is shown here. You can find the source for this in the `uimaj-examples/src/org/apache/uima/tutorial/ex1/RoomNumberAnnotator.java`.

Note: In Eclipse, in the “Package Explorer” view, this will appear by default in the project `uimaj-examples`, in the folder `src`, in the package `org.apache.uima.tutorial.ex1`.

In Eclipse, open the `RoomNumberAnnotator.java` in the `uimaj-examples` project, under the `src` directory.

```
package org.apache.uima.tutorial.ex1;

import java.util.regex.Matcher;
import java.util.regex.Pattern;

import org.apache.uima.analysis_component.JCasAnnotator_ImplBase;
import org.apache.uima.jcas.JCas;
import org.apache.uima.tutorial.RoomNumber;

/**
 * Example annotator that detects room numbers using
 * Java 1.4 regular expressions.
 */
public class RoomNumberAnnotator extends JCasAnnotator_ImplBase {
    private Pattern mYorktownPattern =
        Pattern.compile("\\b[0-4]\\d-[0-2]\\d\\d\\b");

    private Pattern mHawthornePattern =
        Pattern.compile("\\b[G1-4][NS]-[A-Z]\\d\\d\\b");

    public void process(JCas aJCas) {
        // Discussed Later
    }
}
```

The two Java class fields, `mYorktownPattern` and `mHawthornePattern`, hold regular expressions that will be used in the process method. Note that these two fields are part of the Java implementation of the annotator code, and not a part of the CAS type system. We are using the

²Note that `AnalysisComponent` is not specific to JCAS. There is a method `getRequiredCasInterface()` which the user would have to implement to return `JCas.class`. Then in the `process(AbstractCas cas)` method, they would need to typecast `cas` to type `JCas`.

³Although Java classes in which you do not define any constructor will, by default, have a 0-argument constructor that doesn't do anything, a class in which you have defined at least one constructor does not get a default 0-argument constructor.

regular expression facility that is built into Java 1.4. It is not critical that you know the details of how this works, but if you are curious the details can be found in the Java API docs for the `java.util.regex` package.

The only method that we are required to implement is `process`. This method is typically called once for each document that is being analyzed. This method takes one argument, which is a `JCas` instance; this holds the document to be analyzed and all of the analysis results.⁴

```
public void process(JCas aJCas) {
    // get document text
    String docText = aJCas.getDocumentText();
    // search for Yorktown room numbers
    Matcher matcher = mYorktownPattern.matcher(docText);
    int pos = 0;
    while (matcher.find(pos)) {
        // found one - create annotation
        RoomNumber annotation = new RoomNumber(aJCas);
        annotation.setBegin(matcher.start());
        annotation.setEnd(matcher.end());
        annotation.setBuilding("Yorktown");
        annotation.addToIndexes();
        pos = matcher.end();
    }
    // search for Hawthorne room numbers
    matcher = mHawthornePattern.matcher(docText);
    pos = 0;
    while (matcher.find(pos)) {
        // found one - create annotation
        RoomNumber annotation = new RoomNumber(aJCas);
        annotation.setBegin(matcher.start());
        annotation.setEnd(matcher.end());
        annotation.setBuilding("Hawthorne");
        annotation.addToIndexes();
        pos = matcher.end();
    }
}
```

The `Matcher` class is part of the `java.util.regex` package and is used to find the room numbers in the document text. When we find one, recording the annotation is as simple as creating a new Java object and calling some set methods:

```
RoomNumber annotation = new RoomNumber(aJCas);
annotation.setBegin(matcher.start());
annotation.setEnd(matcher.end());
annotation.setBuilding("Yorktown");
```

The `RoomNumber` class was generated from the type system description by the Component Descriptor Editor or the `JCasGen` tool, as discussed in the previous section.

Finally, we call `annotation.addToIndexes()` to add the new annotation to the indexes maintained in the CAS. By default, the CAS implementation used for analysis of text documents keeps an index of all annotations in their order from beginning to end of the document. Subsequent annotators or applications use the indexes to iterate over the annotations.

⁴Version 1 of UIMA specified an additional parameter, the `ResultSpecification`. This provides a specification of which types and features are desired to be computed and "output" from this annotator. Its use is optional; many annotators ignore it.

This parameter has been replaced by specific `set/getResultSpecification()` methods, which allow the annotator to receive a signal (a method call) when the result specification changes.

Note: If you don't add the instance to the indexes, it cannot be retrieved by down-stream annotators, using the indexes.

Note: You can also call `addToIndexes()` on Feature Structures that are not subtypes of `uima.tcas.Annotation`, but these will not be sorted in any particular way. If you want to specify a sort order, you can define your own custom indexes in the CAS: see Chapter 4, *CAS Reference* and Section 2.4.1.7, “Index Definition” for details.

We're almost ready to test the `RoomNumberAnnotator`. There is just one more step remaining.

1.1.4. Creating the XML Descriptor

The UIMA architecture requires that descriptive information about an annotator be represented in an XML file and provided along with the annotator class file(s) to the UIMA framework at run time. This XML file is called an *Analysis Engine Descriptor*. The descriptor includes:

- Name, description, version, and vendor
- The annotator's inputs and outputs, defined in terms of the types in a Type System Descriptor
- Declaration of the configuration parameters that the annotator accepts

The *Component Descriptor Editor* plugin, which we previously used to edit the Type System descriptor, can also be used to edit Analysis Engine Descriptors.

A descriptor for our `RoomNumberAnnotator` is provided with the UIMA distribution under the name `descriptors/tutorial/ex1/RoomNumberAnnotator.xml`. To edit it in Eclipse, right-click on that file in the navigator and select `Open With` → `Component Descriptor Editor`.

Tip: In Eclipse, you can double click on the tab at the top of the Component Descriptor Editor's window identifying the currently selected editor, and the window will “Maximize”. Double click it again to restore the original size.

If you are not using Eclipse, you will need to edit Analysis Engine descriptors manually. See [Section 1.8, “Analysis Engine XML Descriptor” \[39\]](#) for an introduction to the Analysis Engine descriptor XML syntax. The remainder of this section assumes you are using the Component Descriptor Editor plug-in to edit the Analysis Engine descriptor.

The Component Descriptor Editor consists of several tabbed pages; we will only need to use a few of them here. For more information on using this editor, see Chapter 1, *Component Descriptor Editor User's Guide*.

The initial page of the Component Descriptor Editor is the Overview page, which appears as follows:

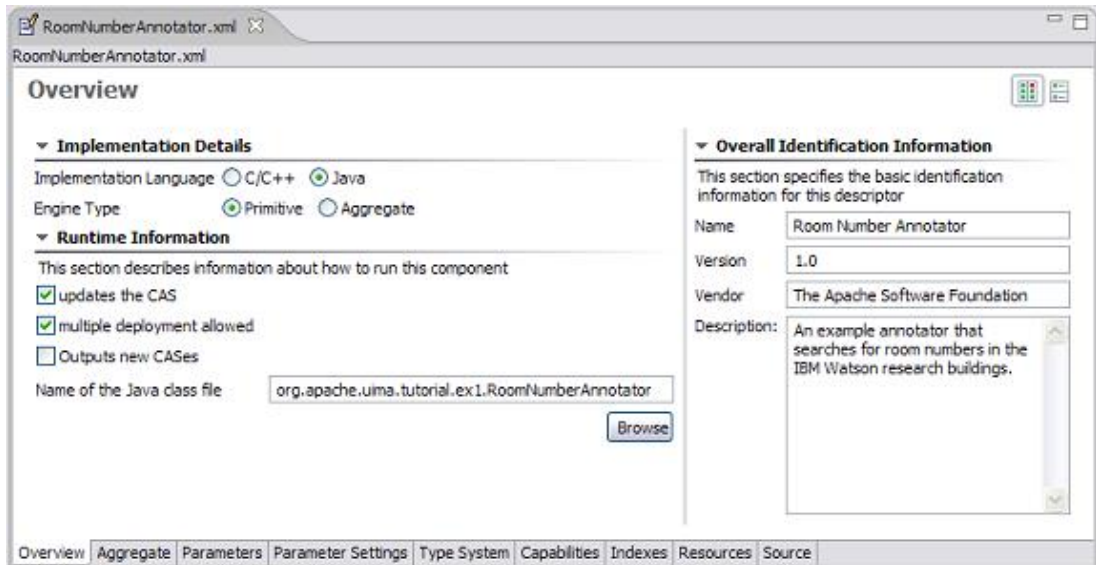

This presents an overview of the RoomNumberAnnotator Analysis Engine (AE). The left side of the page shows that this descriptor is for a *Primitive* AE (meaning it consists of a single annotator), and that the annotator code is developed in Java. Also, it specifies the Java class that implements our logic (the code which was discussed in the previous section). Finally, on the right side of the page are listed some descriptive attributes of our annotator.

The other two pages that need to be filled out are the Type System page and the Capabilities page. You can switch to these pages using the tabs at the bottom of the Component Descriptor Editor. In the tutorial, these are already filled out for you.

The RoomNumberAnnotator will be using the TutorialTypeSystem we looked at in Section [Section 1.1.1, “Defining Types” \[3\]](#). To specify this, we add this type system to the Analysis Engine's list of Imported Type Systems, using the Type System page's right side panel, as shown here:

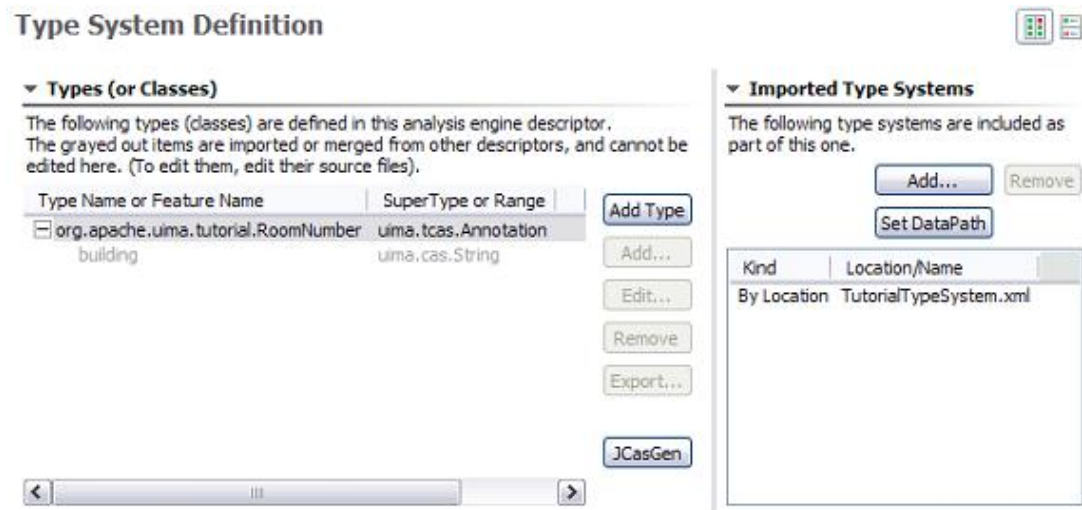

On the Capabilities page, we define our annotator's inputs and outputs, in terms of the types in the type system. The Capabilities page is shown below:

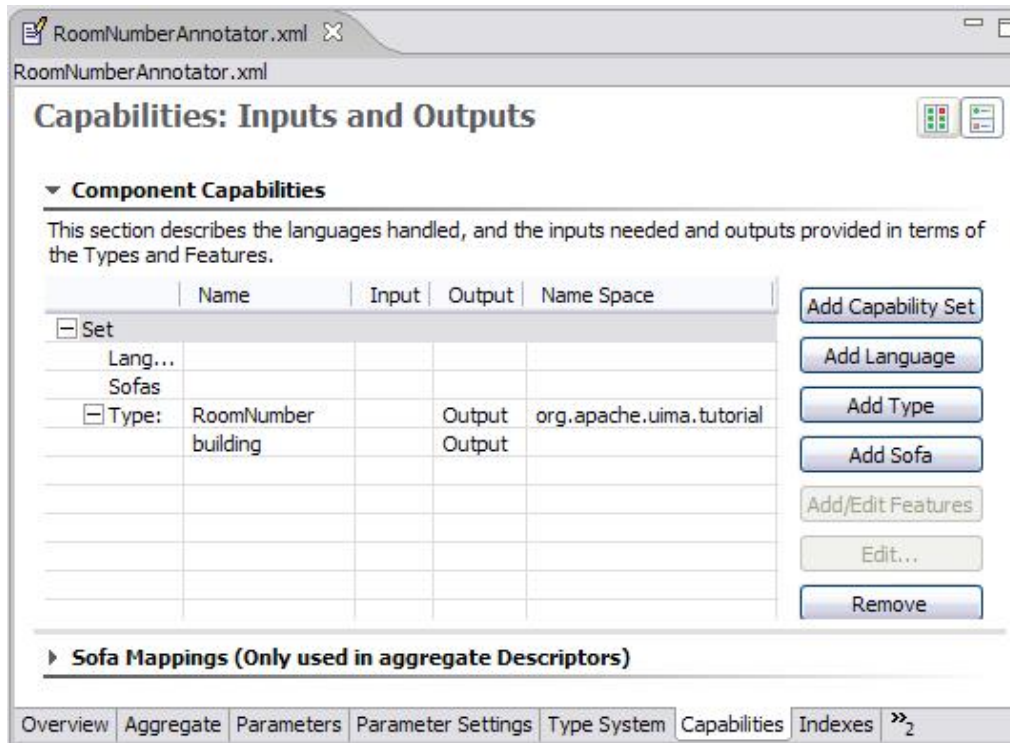

Although capabilities come in sets, having multiple sets is deprecated; here we're just using one set. The RoomNumberAnnotator is very simple. It requires no input types, as it operates directly on the document text -- which is supplied as a part of the CAS initialization (and which is always assumed to be present). It produces only one output type (RoomNumber), and it sets the value of the `building` feature on that type. This is all represented on the Capabilities page.

The Capabilities page has two other parts for specifying languages and Sofas. The languages section allows you to specify which languages your Analysis Engine supports. The RoomNumberAnnotator happens to be language-independent, so we can leave this blank. The Sofas section allows you to specify the names of additional subjects of analysis. This capability and the Sofa Mappings at the bottom are advanced topics, described in Chapter 5, *Annotations, Artifacts, and Sofas*.

This is all of the information we need to provide for a simple annotator. If you want to peek at the XML that this tool saves you from having to write, click on the “Source” tab at the bottom to view the generated XML.

1.1.5. Testing Your Annotator

Having developed an annotator, we need a way to try it out on some example documents. The UIMA SDK includes a tool called the Document Analyzer that will allow us to do this. To run the Document Analyzer, execute the `documentAnalyzer` shell script that is in the `bin` directory of your UIMA SDK installation, or, if you are using the example Eclipse project, execute the “UIMA Document Analyzer” run configuration supplied with that project. (To do this, click on the menu bar `Run` → `Run ...` → and under Java Applications in the left box, click on UIMA Document Analyzer.)

You should see a screen that looks like this:



There are six options on this screen:

1. Directory containing documents to analyze
2. Directory where analysis results will be written
3. The XML descriptor for the Analysis Engine (AE) you want to run
4. (Optional) an XML tag, within the input documents, that contains the text to be analyzed. For example, the value TEXT would cause the AE to only analyze the portion of the document enclosed within `<TEXT>...</TEXT>` tags.
5. Language of the document
6. Character encoding

Use the Browse button next to the third item to set the “Location of AE XML Descriptor” field to the descriptor we’ve just been discussing — `<where-you-installed-uima-e.g.UIMA_HOME> /examples/descriptors/tutorial/ex1/RoomNumberAnnotator.xml`. Set the other fields to the values shown in the screen shot above (which should be the default values if this is the first time you’ve run the Document Analyzer). Then click the “Run” button to start processing.

When processing completes, an “Analysis Results” window should appear.

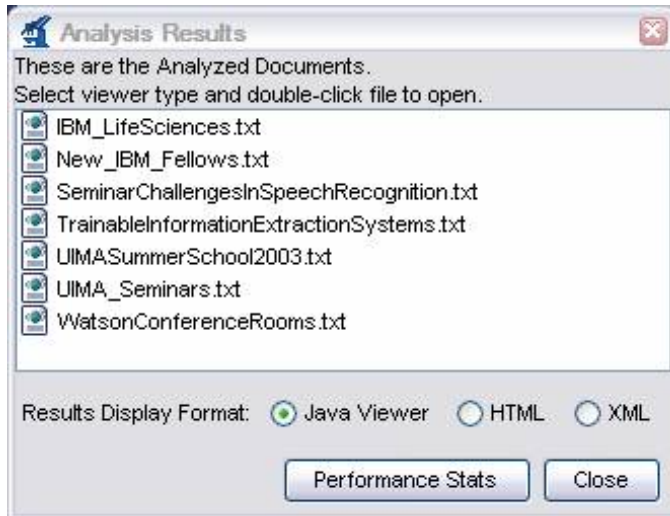

Make sure “Java Viewer” is selected as the Results Display Format, and **double-click** on the document UIMASummerSchool2003.txt to view the annotations that were discovered. The view should look something like this:

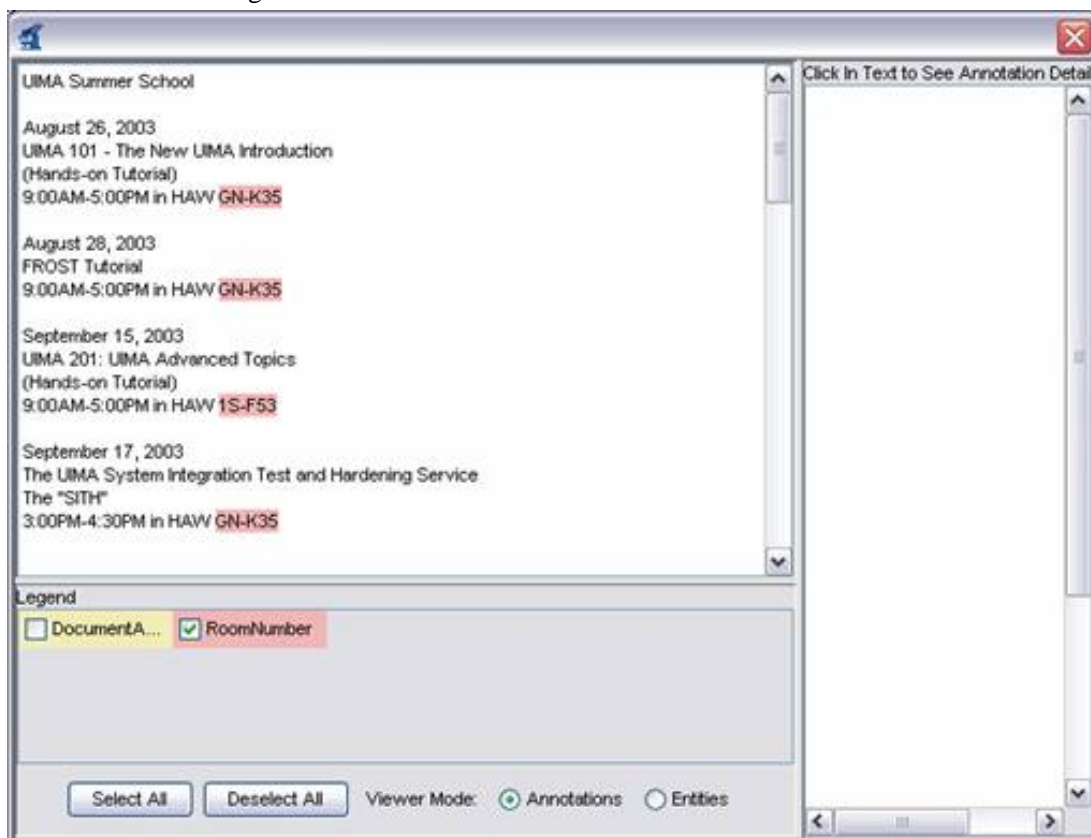

You can click the mouse on one of the highlighted annotations to see a list of all its features in the frame on the right.

Note: The legend will only show those types which have at least one instance in the CAS, and are declared as outputs in the capabilities section of the descriptor (see [Section 1.1.4, “Creating the XML Descriptor”](#) [8]).

You can use the DocumentAnalyzer to test any UIMA annotator — just make sure that the annotator's classes are in the class path.

1.2. Configuration and Logging

1.2.1. Configuration Parameters

The example RoomNumberAnnotator from the previous section used hardcoded regular expressions and location names, which is obviously not very flexible. For example, you might want to have the patterns of room numbers be supplied by a configuration parameter, rather than having to redo the annotator's Java code to add additional patterns. Rather than add a new hardcoded regular expression for a new pattern, a better solution is to use configuration parameters.

UIMA allows annotators to declare configuration parameters in their descriptors. The descriptor also specifies default values for the parameters, though these can be overridden at runtime.

1.2.1.1. Declaring Parameters in the Descriptor

The example descriptor `descriptors/tutorial/ex2/RoomNumberAnnotator.xml` is the same as the descriptor from the previous section except that information has been filled in for the Parameters and Parameter Settings pages of the Component Descriptor Editor.

First, in Eclipse, open example two's RoomNumberAnnotator in the Component Descriptor Editor, and then go to the Parameters page (click on the parameters tab at the bottom of the window), which is shown below:

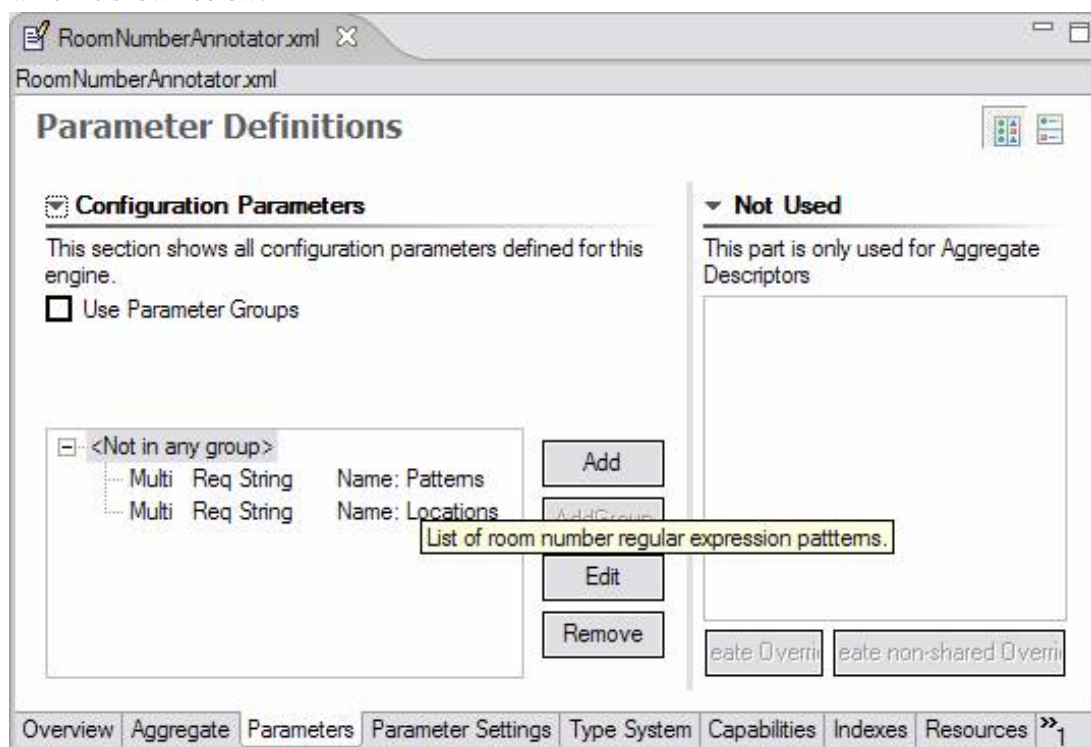

Two parameters – Patterns and Locations -- have been declared. In this screen shot, the mouse (not shown) is hovering over Patterns to show its description in the small popup window. Every parameter has the following information associated with it:

- name – the name by which the annotator code refers to the parameter

- description – a natural language description of the intent of the parameter
- type – the data type of the parameter's value – must be one of String, Integer, Float, or Boolean.
- multiValued – true if the parameter can take multiple-values (an array), false if the parameter takes only a single value. Shown above as `Multi`.
- mandatory – true if a value must be provided for the parameter. Shown above as `Req` (for required).

Both of our parameters are mandatory and accept an array of Strings as their value.

Next, default values are assigned to the parameters on the Parameter Settings page:

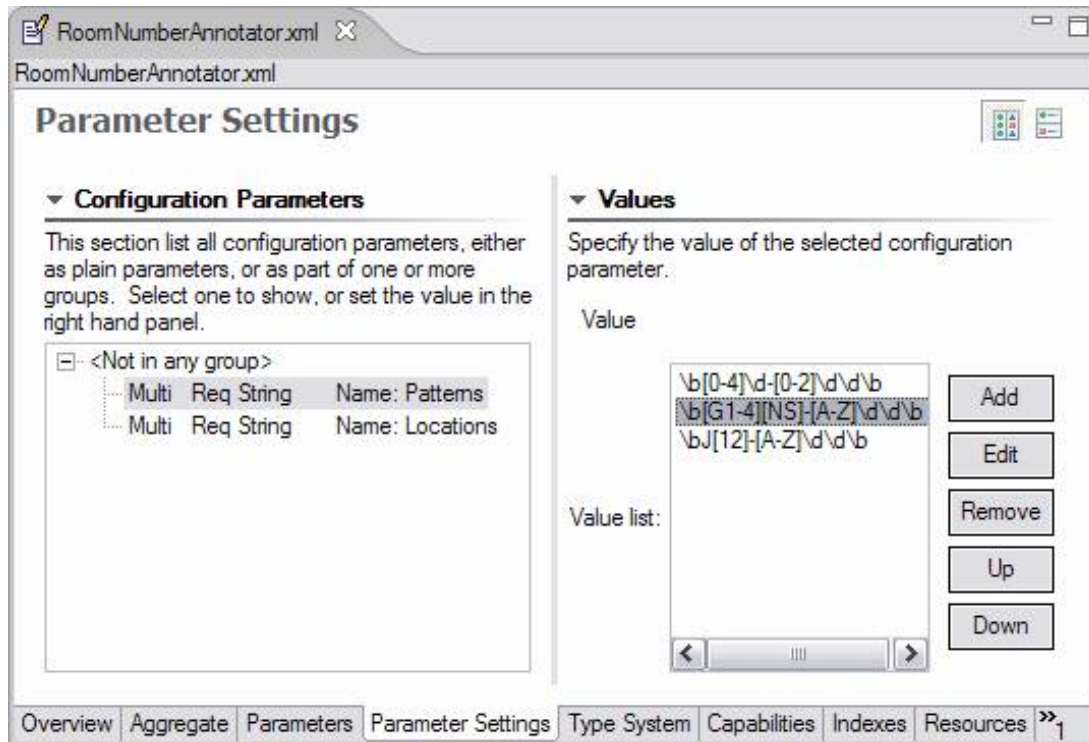

Here the “Patterns” parameter is selected, and the right pane shows the list of values for this parameter, in this case the regular expressions that match particular room numbering conventions. Notice the third pattern is new, for matching the style of room numbers in the third building, which has room numbers such as J2-A11.

1.2.1.2. Accessing Parameter Values from the Annotator Code

The class `org.apache.uima.tutorial.ex2.RoomNumberAnnotator` has overridden the `initialize` method. The `initialize` method is called by the UIMA framework when the annotator is instantiated, so it is a good place to read configuration parameter values. The default `initialize` method does nothing with configuration parameters, so you have to override it. To see the code in Eclipse, switch to the `src` folder, and open `org.apache.uima.tutorial.ex2`. Here is the method body:

```
/**
 * @see AnalysisComponent#initialize(UimaContext)
```

```
*/
public void initialize(UimaContext aContext)
    throws ResourceInitializationException {
    super.initialize(aContext);

    // Get config. parameter values
    String[] patternStrings =
        (String[]) aContext.getConfigParameterValue("Patterns");
    mLocations =
        (String[]) aContext.getConfigParameterValue("Locations");

    // compile regular expressions
    mPatterns = new Pattern[patternStrings.length];
    for (int i = 0; i < patternStrings.length; i++) {
        mPatterns[i] = Pattern.compile(patternStrings[i]);
    }
}
```

Configuration parameter values are accessed through the `UimaContext`. As you will see in subsequent sections of this chapter, the `UimaContext` is the annotator's access point for all of the facilities provided by the UIMA framework – for example logging and external resource access.

The `UimaContext`'s `getConfigParameterValue` method takes the name of the parameter as an argument; this must match one of the parameters declared in the descriptor. The return value of this method is a Java Object, whose type corresponds to the declared type of the parameter. It is up to the annotator to cast it to the appropriate type, `String[]` in this case.

If there is a problem retrieving the parameter values, the framework throws an exception. Generally annotators don't handle these, and just let them propagate up.

To see the configuration parameters working, run the Document Analyzer application and select the descriptor `examples/descriptors/tutorial/ex2/RoomNumberAnnotator.xml`. In the example document `WatsonConferenceRooms.txt`, you should see some examples of Hawthorne II room numbers that would not have been detected by the `ex1` version of `RoomNumberAnnotator`.

1.2.1.3. Supporting Reconfiguration

If you take a look at the Javadocs (located in the [docs/api⁵](#) directory) for `org.apache.uima.analysis_component.AnalysisComponent` (which our annotator implements indirectly through `JCasAnnotator_ImplBase`), you will see that there is a `reconfigure()` method, which is called by the containing application through the UIMA framework, if the configuration parameter values are changed.

The `AnalysisComponent_ImplBase` class provides a default implementation that just calls the annotator's `destroy` method followed by its `initialize` method. This works fine for our annotator. The only situation in which you might want to override the default `reconfigure()` is if your annotator has very expensive initialization logic, and you don't want to reinitialize everything if just one configuration parameter has changed. In that case, you can provide a more intelligent implementation of `reconfigure()` for your annotator.

1.2.1.4. Configuration Parameter Groups

For annotators with many sets of configuration parameters, UIMA supports organizing them into groups. It is possible to define a parameter with the same name in multiple groups; one common

⁵ [api/index.html](#)

use for this is for annotators that can process documents in several languages and which want to have different parameter settings for the different languages.

The syntax for defining parameter groups in your descriptor is fairly straightforward – see Chapter 2, *Component Descriptor Reference* for details. Values of parameters defined within groups are accessed through the two-argument version of `UimaContext.getConfigParameterValue`, which takes both the group name and the parameter name as its arguments.

1.2.2. Logging

The UIMA SDK provides a logging facility, which is very similar to the `java.util.logging.Logger` class that was introduced in Java 1.4.

In the Java architecture, each logger instance is associated with a name. By convention, this name is often the fully qualified class name of the component issuing the logging call. The name can be referenced in a configuration file when specifying which kinds of log messages to actually log, and where they should go.

The UIMA framework supports this convention using the `UimaContext` object. If you access a logger instance using `getContext().getLogger()` within an Annotator, the logger name will be the fully qualified name of the Annotator implementation class.

Here is an example from the process method of `org.apache.uima.tutorial.ex2.RoomNumberAnnotator`:

```
getContext().getLogger().log(Level.FINEST, "Found: " + annotation);
```

The first argument to the log method is the level of the log output. Here, a value of `FINEST` indicates that this is a highly-detailed tracing message. While useful for debugging, it is likely that real applications will not output log messages at this level, in order to improve their performance. Other defined levels, from lowest to highest importance, are `FINER`, `FINE`, `CONFIG`, `INFO`, `WARNING`, and `SEVERE`.

If no logging configuration file is provided (see next section), the Java Virtual Machine defaults would be used, which typically set the level to `INFO` and higher messages, and direct output to the console.

If you specify the standard UIMA SDK `Logger.properties`, the output will be directed to a file named `uima.log`, in the current working directory (often the “project” directory when running from Eclipse, for instance).

Note: When using Eclipse, the `uima.log` file, if written into the Eclipse workspace in the project `uimaj-examples`, for example, may not appear in the Eclipse package explorer view until you right-click the `uimaj-examples` project with the mouse, and select “Refresh”. This operation refreshes the Eclipse display to conform to what may have changed on the file system. Also, you can set the Eclipse preferences for the workspace to automatically refresh (Window → Preferences → General → Workspace, then click the “refresh automatically” checkbox).

1.2.2.1. Specifying the Logging Configuration

The standard UIMA logger uses the underlying Java 1.4 logging mechanism. You can use the APIs that come with that to configure the logging. In addition, the standard Java 1.4 logging initialization

mechanisms will look for a Java System Property named `java.util.logging.config.file` and if found, will use the value of this property as the name of a standard “properties” file, for setting the logging level. Please refer to the Java 1.4. documentation for more information on the format and use of this file.

Two sample logging specification property files can be found in the `UIMA_HOME` directory where the UIMA SDK is installed: `config/Logger.properties`, and `config/FileConsoleLogger.properties`. These specify the same logging, except the first logs just to a file, while the second logs both to a file and to the console. You can edit these files, or create additional ones, as described below, to change the logging behavior.

When running your own Java application, you can specify the location of the logging configuration file on your Java command line by setting the Java system property `java.util.logging.config.file` to be the logging configuration filename. This file specification can be either absolute or relative to the working directory. For example:

```
java "-Djava.util.logging.config.file=C:/Program Files/apache-uima/config/Logger.properties"
```

Note: In a shell script, you can use environment variables such as `UIMA_HOME` if convenient.

If you are using Eclipse to launch your application, you can set this property in the VM arguments section of the Arguments tab of the run configuration screen. If you've set an environment variable `UIMA_HOME`, you could for example, use the string: `"-Djava.util.logging.config.file=${env_var:UIMA_HOME}/config/Logger.properties"`.

If you running the `.bat` or `.sh` files in the UIMA SDK's `bin` directory, you can specify the location of your logger configuration file by setting the `UIMA_LOGGER_CONFIG_FILE` environment variable prior to running the script, for example (on Windows):

```
set UIMA_LOGGER_CONFIG_FILE=C:/myapp/MyLogger.properties
```

1.2.2.2. Setting Logging Levels

Within the logging control file, the default global logging level specifies which kinds of events are logged across all loggers. For any given facility this global level can be overridden by a facility specific level. Multiple handlers are supported. This allows messages to be directed to a log file, as well as to a “console”. Note that the `ConsoleHandler` also has a separate level setting to limit messages printed to the console. For example: `.level= INFO`

The properties file can change where the log is written, as well.

Facility specific properties allow different logging for each class, as well. For example, to set the `com.xyz.foo` logger to only log `SEVERE` messages: `com.xyz.foo.level = SEVERE`

If you have a sample annotator in the package `org.apache.uima.SampleAnnotator` you can set the log level by specifying: `org.apache.uima.SampleAnnotator.level = ALL`

There are other logging controls; for a full discussion, please read the contents of the `Logger.properties` file and the Java specification for logging in Java 1.4.

1.2.2.3. Format of logging output

The logging output is formatted by handlers specified in the properties file for configuring logging, described above. The default formatter that comes with the UIMA SDK formats logging output as follows:

Timestamp - threadID: sourceInfo: Message level: message

Here's an example:

```
7/12/04 2:15:35 PM - 10: org.apache.uima.util.TestClass.main(62): INFO:
You are not logged in!
```

1.2.2.4. Meaning of the logging severity levels

These levels are defined by the Java logging framework, which was incorporated into Java as of the 1.4 release level. The levels are defined in the Javadocs for `java.util.logging.Level`, and include both logging and tracing levels:

- OFF is a special level that can be used to turn off logging.
- ALL indicates that all messages should be logged.
- CONFIG is a message level for configuration messages. These would typically occur once (during configuration) in methods like `initialize()`.
- INFO is a message level for informational messages, for example, connected to server IP: 192.168.120.12
- WARNING is a message level indicating a potential problem.
- SEVERE is a message level indicating a serious failure.

Tracing levels, typically used for debugging:

- FINE is a message level providing tracing information, typically at a collection level (messages occurring once per collection).
- FINER indicates a fairly detailed tracing message, typically at a document level (once per document).
- FINEST indicates a highly detailed tracing message.

1.2.2.5. Using the logger outside of an annotator

An application using UIMA may want to log its messages using the same logging framework. This can be done by getting a reference to the UIMA logger, as follows:

```
Logger logger = UIMAFramework.getLogger(TestClass.class);
```

The optional class argument allows filtering by class (if the log handler supports this). If not specified, the name of the returned logger instance is “org.apache.uima”.

1.2.2.6. Changing the underlying UIMA logging implementation

By default the UIMA framework use, under the hood of the UIMA Logger interface, the Java logging framework to do logging. But it is possible to change the logging implementation that UIMA use from Java logging to an arbitrary logging system when specifying the system property

```
-Dorg.apache.uima.logger.class=<loggerClass>
```

when the UIMA framework is started.

The specified logger class must be available in the classpath and have to implement the `org.apache.uima.util.Logger` interface.

UIMA also provides a logging implementation that use Apache Log4j instead of Java logging. To use Log4j you have to provide the Log4j jars in the classpath and your application must specify the logging configuration as shown below.

```
-Dorg.apache.uima.logger.class=<org.apache.uima.util.impl.Log4jLogger_impl>
```

1.3. Building Aggregate Analysis Engines

1.3.1. Combining Annotators

The UIMA SDK makes it very easy to combine any sequence of Analysis Engines to form an *Aggregate Analysis Engine*. This is done through an XML descriptor; no Java code is required!

If you go to the `examples/descriptors/tutorial/ex3` folder (in Eclipse, it's in your `uimaj-examples` project, under the `descriptors/tutorial/ex3` folder), you will find a descriptor for a `TutorialDateTime` annotator. This annotator detects dates and times. To see what this annotator can do, try it out using the Document Analyzer. If you are curious as to how this annotator works, the source code is included, but it is not necessary to understand the code at this time.

We are going to combine the `TutorialDateTime` annotator with the `RoomNumberAnnotator` to create an aggregate Analysis Engine. This is illustrated in the following figure:

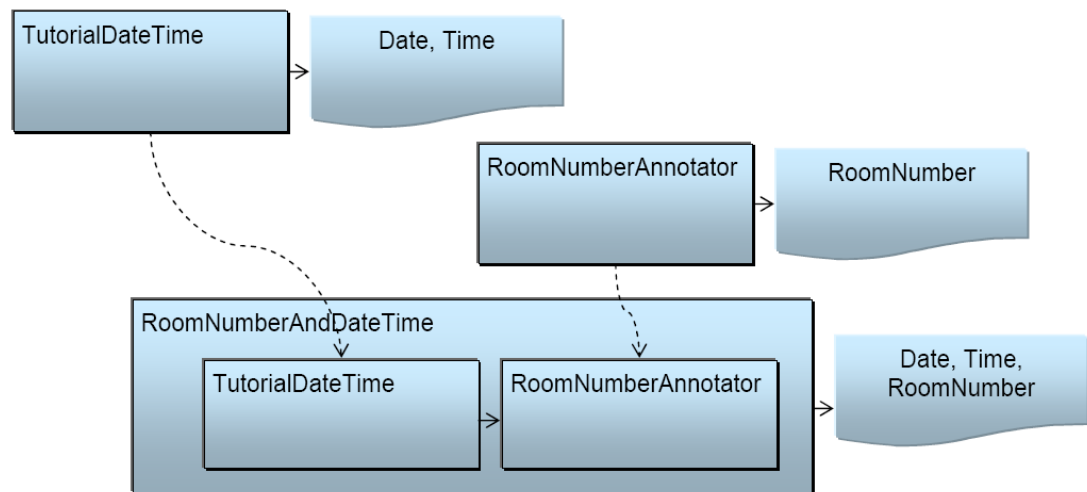
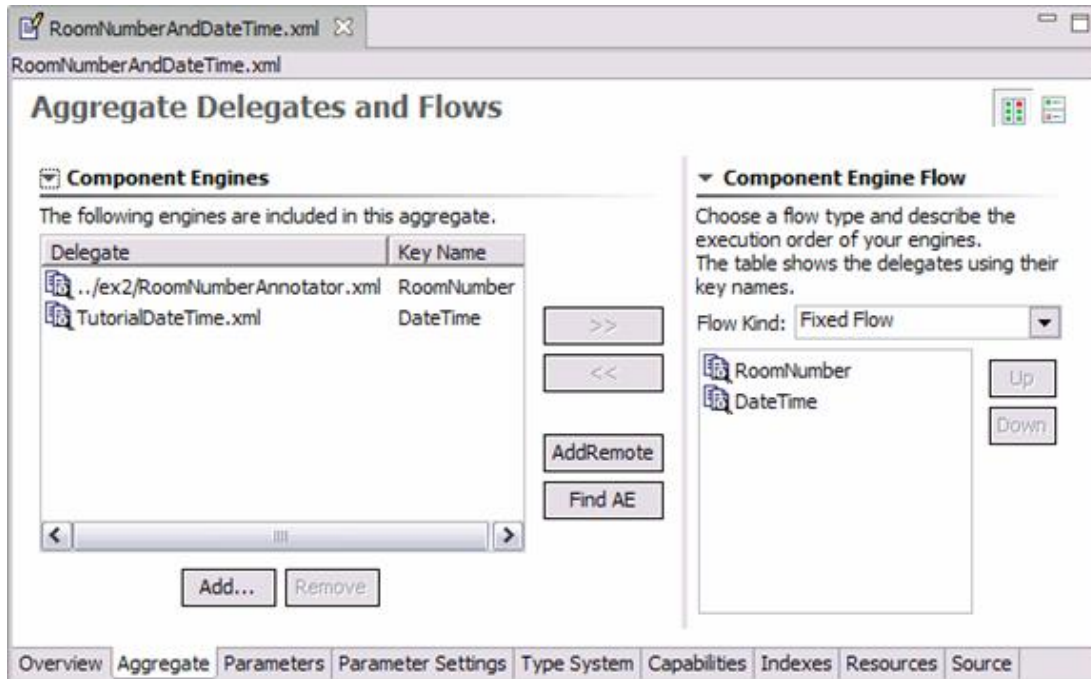

Figure 1.1. Combining Annotators to form an Aggregate Analysis Engine

The descriptor that does this is named `RoomNumberAndDateTime.xml`, which you can open in the Component Descriptor Editor plug-in. This is in the `uimaj-examples` project in the folder `descriptors/tutorial/ex3`.

The “Aggregate” page of the Component Descriptor Editor is used to define which components make up the aggregate. A screen shot is shown below. (If you are not using Eclipse, see [Section 1.8, “Analysis Engine XML Descriptor”](#) [39] for the actual XML syntax for Aggregate Analysis Engine Descriptors.)



On the left side of the screen is the list of component engines that make up the aggregate – in this case, the TutorialDateTime annotator and the RoomNumberAnnotator. To add a component, you can click the “Add” button and browse to its descriptor. You can also click the “Find AE” button and search for an Analysis Engine in your Eclipse workspace.

Note: The “AddRemote” button is used for adding components which run remotely (for example, on another machine using a remote networking connection). This capability is described in section Section 3.6.3, “Calling a UIMA Service”,

The order of the components in the left pane does not imply an order of execution. The order of execution, or “flow” is determined in the “Component Engine Flow” section on the right. UIMA supports different types of algorithms (including user-definable) for determining the flow. Here we pick the simplest: `FixedFlow`. We have chosen to have the RoomNumberAnnotator execute first, although in this case it doesn't really matter, since the RoomNumber and DateTime annotators do not have any dependencies on one another.

If you look at the “Type System” page of the Component Descriptor Editor, you will see that it displays the type system but is not editable. The Type System of an Aggregate Analysis Engine is automatically computed by merging the Type Systems of all of its components.

Warning: If the components have different definitions for the same type name, The Component Descriptor Editor will show a warning. It is possible to continue past this warning, in which case your aggregate's type system will have the correct “merged” type definition that contains all of the features defined on that type by all of your components. However, it is not recommended to use this feature in conjunction with JCAS, since the JCAS Java Class definitions cannot be so easily merged. See Section 5.5, “Merging Types” for more information.

The Capabilities page is where you explicitly declare the aggregate Analysis Engine's inputs and outputs. Sofas and Languages are described later.

Capabilities: Inputs and Outputs

▼ **Component Capabilities**

This section describes the languages handled, and the inputs needed and outputs provided in terms of the Types and Features.

	Name	Input	Output	Name Space
[-] Set				
[-] Languages	en			
Sofas				
[-] Type:	DateAnnot		Output	org.apache.uima.tutorial
	<all features>		Output	
[-] Type:	RoomNumber		Output	org.apache.uima.tutorial
	<all features>		Output	
[-] Type:	TimeAnnot		Output	org.apache.uima.tutorial
	<all features>		Output	

► **Sofa Mappings (No Sofas are defined)**

Overview | Aggregate | Parameters | Parameter Settings | Type System | **Capabilities** | Indexes | Resources | Source

Control buttons: Add Capability Set, Add Language, Add Type, Add Sofa, Add/Edit Features, Edit..., Remove

Note that it is not automatically assumed that all outputs of each component Analysis Engine (AE) are passed through as outputs of the aggregate AE. If, for example, the TutorialDateTime annotator also produced Word and Sentence annotations, but those were not of interest as output in this case, we can exclude them from the list of outputs.

You can run this AE using the Document Analyzer in the same way that you run any other AE. Just select the `examples/descriptors/tutorial/ex3/RoomNumberAndDateTime.xml` descriptor and click the Run button. You should see that RoomNumbers, Dates, and Times are all shown:

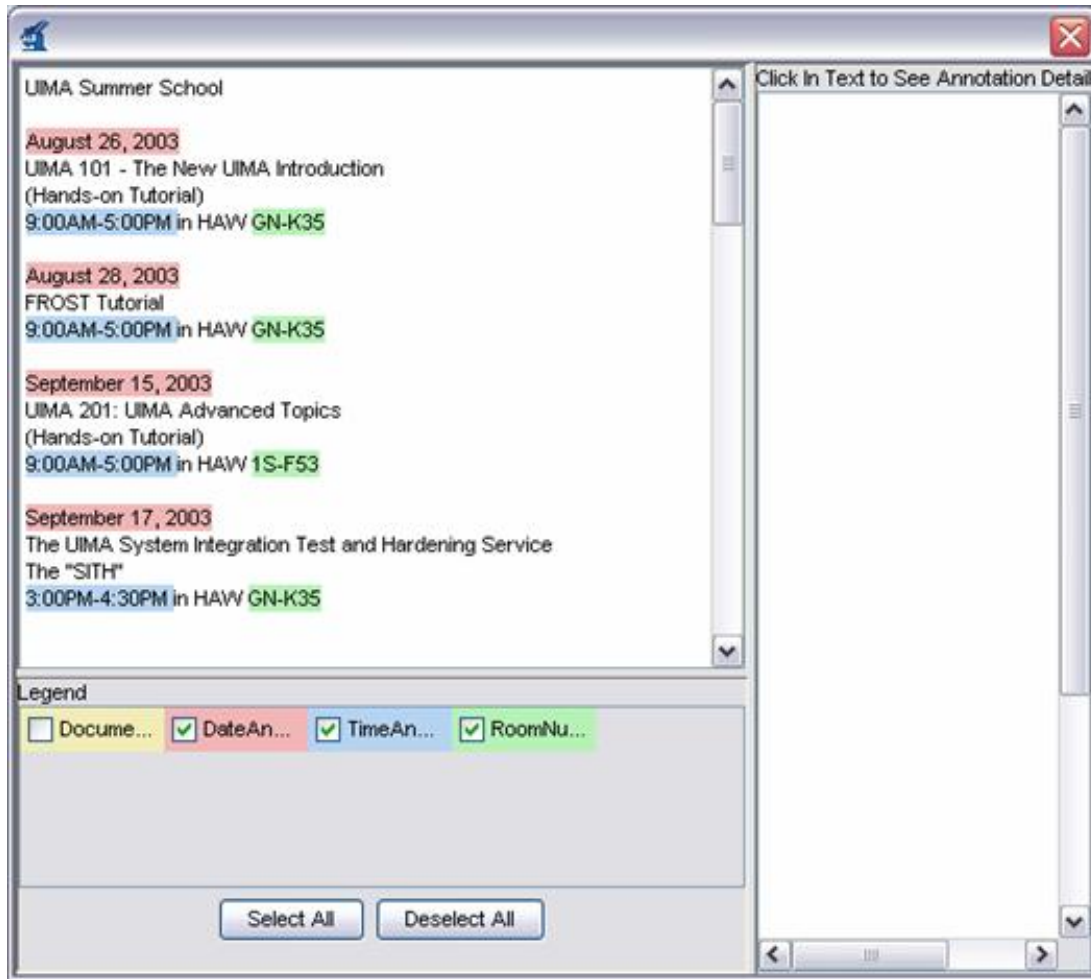

1.3.2. AAEs can also contain CAS Consumers

In addition to aggregating Analysis Engines, Aggregates can also contain CAS Consumers (see Chapter 2, *Collection Processing Engine Developer's Guide*, or even a mixture of these components with regular Analysis Engines. The UIMA Examples has an example of an Aggregate which contains both an analysis engine and a CAS consumer, in `examples/descriptors/MixedAggregate.xml`.

Analysis Engines support the `collectionProcessComplete` method, which is particularly important for many CAS Consumers. If an application (or a Collection Processing Engine) calls `collectionProcessComplete` on an aggregate, the framework will deliver that call to all of the components of the aggregate. If you use one of the built-in flow types (`fixedFlow` or `capabilityLanguageFlow`), then the order specified in that flow will be the same order in which the `collectionProcessComplete` calls are made to the components. If a custom flow is used, then the calls will be made in arbitrary order.

1.3.3. Reading the Results of Previous Annotators

So far, we have been looking at annotators that look directly at the document text. However, annotators can also use the results of other annotators. One useful thing we can do at this point is look for the co-occurrence of a Date, a RoomNumber, and two Times – and annotate that as a Meeting.

The CAS maintains *indexes* of annotations, and from an index you can obtain an iterator that allows you to step through all annotations of a particular type. Here's some example code that would iterate over all of the TimeAnnot annotations in the JCas:

```
FSIndex timeIndex = aJCas.getAnnotationIndex(TimeAnnot.type);
Iterator timeIter = timeIndex.iterator();
while (timeIter.hasNext()) {
    TimeAnnot time = (TimeAnnot)timeIter.next();

    //do something
}
```

Note: You can also use the method

`JCAS.getJFSIndexRepository().getAllIndexedFS(YourClass.type)`, which returns an iterator over all instances of `YourClass` in no particular order. This can be useful for types that are not subtypes of the built-in Annotation type and which therefore have no default sort order.

Now that we've explained the basics, let's take a look at the process method for `org.apache.uima.tutorial.ex4.MeetingAnnotator`. Since we're looking for a combination of a RoomNumber, a Date, and two Times, there are four nested iterators. (There's surely a better algorithm for doing this, but to keep things simple we're just going to look at every combination of the four items.)

For each combination of the four annotations, we compute the span of text that includes all of them, and then we check to see if that span is smaller than a “window” size, a configuration parameter. There are also some checks to make sure that we don't annotate the same span of text multiple times. If all the checks pass, we create a Meeting annotation over the whole span. There's really nothing to it!

The XML descriptor, located in `examples/descriptors/tutorial/ex4/MeetingAnnotator.xml`, is also very straightforward. An important difference from previous descriptors is that this is the first annotator we've discussed that has input requirements. This can be seen on the “Capabilities” page of the Component Descriptor Editor:

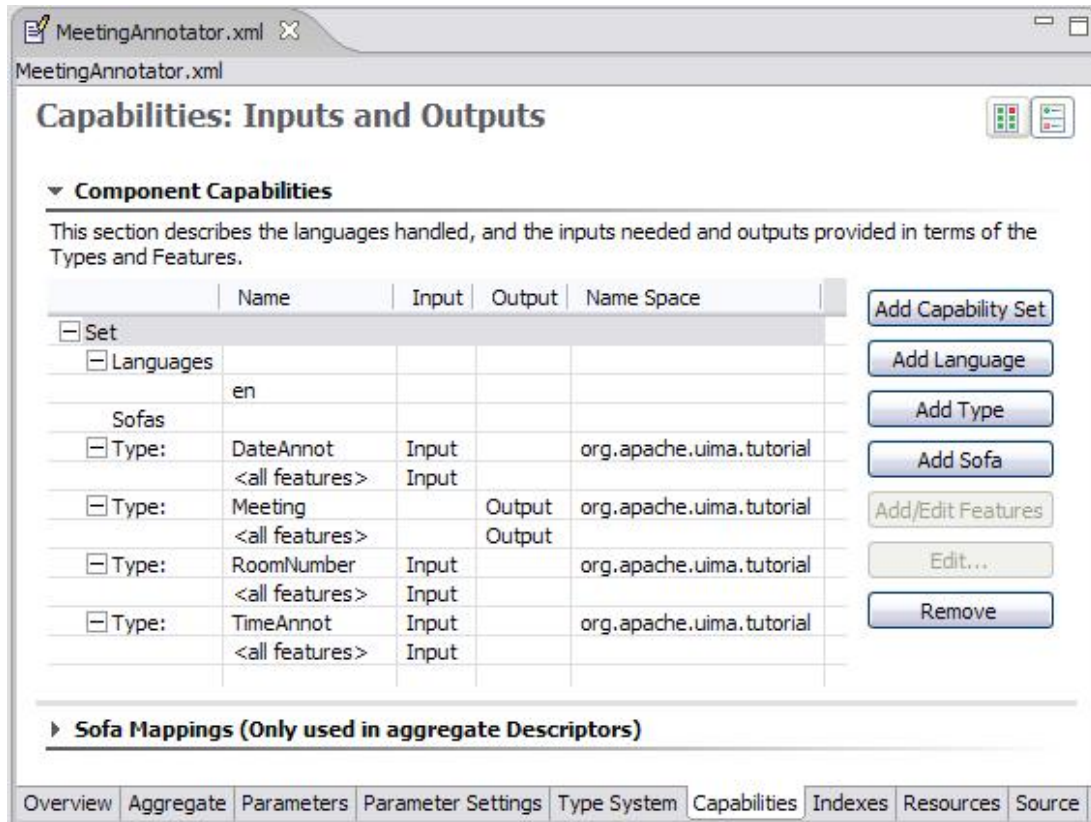

If we were to run the MeetingAnnotator on its own, it wouldn't detect anything because it wouldn't have any input annotations to work with. The required input annotations can be produced by the RoomNumber and DateTime annotators. So, we create an aggregate Analysis Engine containing these two annotators, followed by the Meeting annotator. This aggregate is illustrated in Figure 1.2, “An Aggregate Analysis Engine where an internal component uses output from previous engines” [24]. The descriptor for this is in `examples/descriptors/tutorial/ex4/MeetingDetectorAE.xml`. Give it a try in the Document Analyzer.

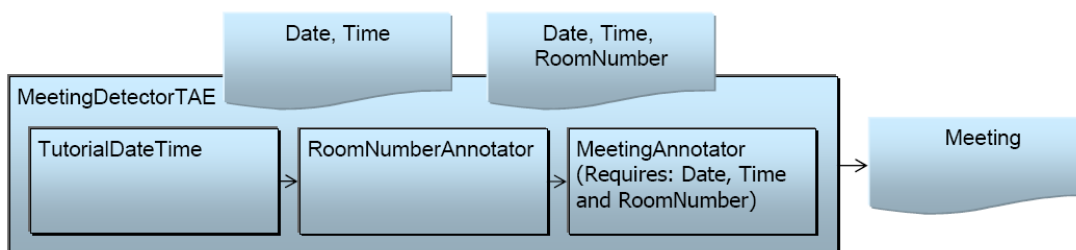

Figure 1.2. An Aggregate Analysis Engine where an internal component uses output from previous engines

1.4. Other examples

The UIMA SDK include several other examples you may find interesting, including

- SimpleTokenAndSentenceAnnotator – a simple tokenizer and sentence annotator.
- XmlDetagger – A multi-sofa annotator that does XML detagging. Multiple Sofas (Subjects of Analysis) are described in a later – see Chapter 6, *Multiple CAS Views of an Artifact*. Reads XML data from the input Sofa (named "xmlDocument"); this data can be stored

in the CAS as a string or array, or it can be a URI to a remote file. The XML is parsed using the JVM's default parser, and the plain-text content is written to a new sofa called "plainTextDocument".

- `PersonTitleDBWriterCasConsumer` – a sample CAS Consumer which populates a relational database with some annotations. It uses JDBC and in this example, hooks up with the Open Source Apache Derby database.

1.5. Additional Topics

1.5.1. Contract: Annotator Methods Called by the Framework

The UIMA framework ensures that an Annotator instance is called by only one thread at a time. An instance never has to worry about running some method on one thread, and then asynchronously being called using another thread. This approach simplifies the design of annotators – they do not have to be designed to support multi-threading. When multiple threading is wanted, for performance, multiple instances of the Annotator are created, each one running on just one thread.

The following table defines the methods called by the framework, when they are called, and the requirements annotator implementations must follow.

Method	When Called by Framework	Requirements
<code>initialize</code>	Typically only called once, when instance is created. Can be called again if application does a <code>reinitialize</code> call and the default behavior isn't overridden (the default behavior for <code>reinitialize</code> is to call <code>destroy</code> followed by <code>initialize</code>).	Normally does one-time initialization, including reading of configuration parameters. If the application changes the parameters, it can call <code>initialize</code> to have the annotator re-do its initialization.
<code>typeSystemInit</code>	Called before <code>process</code> whenever the type system in the CAS being passed in differs from what was previously passed in a <code>process</code> call (and called for the first CAS passed in, too). The Type System being passed to an annotator only changes in the case of remote annotators that are active as servers, receiving possibly different type systems to operate on.	Typically, users of JCas do not implement any method for this. An annotator can use this call to read the CAS type system and setup any instance variables that make accessing the types and features convenient.
<code>process</code>	Called once for each CAS. Called by the application if not using Collection Processing Manager (CPM); the application calls the <code>process</code> method on the analysis engine, which is then delegated by the framework to all the annotators in the engine. For Collection Processing application, the CPM calls the <code>process</code> method. If the application creates and manages your own Collection Processing	Process the CAS, adding and/or modifying elements in it

Method	When Called by Framework	Requirements
	Engine via API calls (see Javadocs), the application calls this on the Collection Processing Engine, and it is delegated by the framework to the components.	
destroy	This method can be called by applications, and is also called by the Collection Processing Manager framework when the collection processing completes. It is also called on Aggregate delegate components, if those components successfully complete their <code>initialize</code> call, if a subsequent delegate (or flow controller) in the aggregate fails to initialize. This allows components which need to clean up things done during initialization to do so. It is up to the component writer to use a try/finally construct during initialization to cleanup from errors that occur during initialization within one component. The <code>destroy</code> call on an aggregate is propagated to all contained analysis engines.	An annotator should release all resources, close files, close database connections, etc., and return to a state where another initialize call could be received to restart. Typically, after a destroy call, no further calls will be made to an annotator instance.
reconfigure	This method is never called by the framework, unless an application calls it on the Engine object – in which case it the framework propagates it to all annotators contained in the Engine. Its purpose is to signal that the configuration parameters have changed.	A default implementation of this calls <code>destroy</code> , followed by <code>initialize</code> . This is the only case where <code>initialize</code> would be called more than once. Users should implement whatever logic is needed to return the annotator to an initialized state, including re-reading the configuration parameter data.

1.5.2. Reporting errors from Annotators

There are two broad classes of errors that can occur: recoverable and unrecoverable. Because Annotators are often expected to process very large numbers of artifacts (for example, text documents), they should be written to recover where possible.

For example, if an upstream annotator created some input for an annotator which is invalid, the annotator may want to log this event, ignore the bad input and continue. It may include a notification of this event in the CAS, for further downstream annotators to consider. Or, it may throw an exception (see next section) – but in this case, it cannot do any further processing on that document.

Note: The choice of what to do can be made configurable, using the configuration parameters.

1.5.3. Throwing Exceptions from Annotators

Let's say an invalid regular expression was passed as a parameter to the RoomNumberAnnotator. Because this is an error related to the overall configuration, and not something we could expect to ignore, we should throw an appropriate exception, and most Java programmers would expect to do so like this:

```
throw new ResourceInitializationException(  
    "The regular expression " + x + " is not valid.");
```

UIMA, however, does not do it this way. All UIMA exceptions are *internationalized*, meaning that they support translation into other languages. This is accomplished by eliminating hardcoded message strings and instead using external message digests. Message digests are files containing (key, value) pairs. The key is used in the Java code instead of the actual message string. This allows the message string to be easily translated later by modifying the message digest file, not the Java code. Also, message strings in the digest can contain parameters that are filled in when the exception is thrown. The format of the message digest file is described in the Javadocs for the Java class `java.util.PropertyResourceBundle` and in the `load` method of `java.util.Properties`.

The first thing an annotator developer must choose is what Exception class to use. There are three to choose from:

1. `ResourceConfigurationException` should be thrown from the annotator's `reconfigure()` method if invalid configuration parameter values have been specified.
2. `ResourceInitializationException` should be thrown from the annotator's `initialize()` method if initialization fails for any reason (including invalid configuration parameters).
3. `AnalysisEngineProcessException` should be thrown from the annotator's `process()` method if the processing of a particular document fails for any reason.

Generally you will not need to define your own custom exception classes, but if you do they must extend one of these three classes, which are the only types of Exceptions that the annotator interface permits annotators to throw.

All of the UIMA Exception classes share common constructor varieties. There are four possible arguments:

The name of the message digest to use (optional – if not specified the default UIMA message digest is used).

The key string used to select the message in the message digest.

An object array containing the parameters to include in the message. Messages can have substitutable parts. When the message is given, the string representation of the objects passed are substituted into the message. The object array is often created using the syntax `new Object[]{x, y}`.

Another exception which is the “cause” of the exception you are throwing. This feature is commonly used when you catch another exception and rethrow it. (optional)

If you look at source file (folder: `src` in Eclipse)

`org.apache.uima.tutorial.ex5.RoomNumberAnnotator`, you will see the following code:

```

try {
    mPatterns[i] = Pattern.compile(patternStrings[i]);
}
catch (PatternSyntaxException e) {
    throw new ResourceInitializationException(
        MESSAGE_DIGEST, "regex_syntax_error",
        new Object[]{patternStrings[i]}, e);
}
    
```

where the `MESSAGE_DIGEST` constant has the value
`"org.apache.uima.tutorial.ex5.RoomNumberAnnotator_Messages"`.

Message digests are specified using a dotted name, just like Java classes. This file, with the `.properties` extension, must be present in the class path. In Eclipse, you find this file under the `src` folder, in the package `org.apache.uima.tutorial.ex5`, with the name `RoomNumberAnnotator_Messages.properties`. Outside of Eclipse, you can find this in the `uimaj-examples.jar` with the name `org/apache/uima/tutorial/ex5/RoomNumberAnnotator_Messages.properties`. If you look in this file you will see the line:

```
regex_syntax_error = {0} is not a valid regular expression.
```

which is the error message for the example exception we showed above. The placeholder `{0}` will be filled by the `toString()` value of the argument passed to the exception constructor – in this case, the regular expression pattern that didn't compile. If there were additional arguments, their locations in the message would be indicated as `{1}`, `{2}`, and so on.

If a message digest is not specified in the call to the exception constructor, the default is `UIMAException.STANDARD_MESSAGE_CATALOG` (whose value is `"org.apache.uima.UIMAException_Messages"` in the current release but may change). This message digest is located in the `uima-core.jar` file at `org/apache/uima/UIMAException_messages.properties` – you can take a look to see if any of these exception messages are useful to use.

To try out the `regex_syntax_error` exception, just use the Document Analyzer to run `examples/descriptors/tutorial/ex5/RoomNumberAnnotator.xml`, which happens to have an invalid regular expression in its configuration parameter settings.

To summarize, here are the steps to take if you want to define your own exception message:

Create a file with the `.properties` extension, where you declare message keys and their associated messages, using the same syntax as shown above for the `regex_syntax_error` exception. The properties file syntax is more completely described in the Javadocs for the `load`⁶ method of the `java.util.Properties` class.

Put your properties file somewhere in your class path (it can be in your annotator's `.jar` file).

Define a String constant (called `MESSAGE_DIGEST` for example) in your annotator code whose value is the dotted name of this properties file. For example, if your properties file is inside your jar file at the location `org/myorg/myannotator/Messages.properties`, then this String constant should have the value `org.myorg.myannotator.Messages`. Do not include the `.properties` extension. In Java Internationalization terminology, this is called the Resource Bundle name. For more information see the Javadocs for the `PropertyResourceBundle`⁷ class.

⁶ [http://java.sun.com/j2se/1.5.0/docs/api/java/util/Properties.html#load\(java.io.InputStream\)](http://java.sun.com/j2se/1.5.0/docs/api/java/util/Properties.html#load(java.io.InputStream))

⁷ <http://java.sun.com/j2se/1.5.0/docs/api/java/util/PropertyResourceBundle.html>

In your annotator code, throw an exception like this:

```
throw new ResourceInitializationException(  
    MESSAGE_DIGEST, "your_message_name",  
    new Object[] {param1, param2, ...});
```

You may also wish to look at the Javadocs for the `UIMAException` class.

For more information on Java's internationalization features, see the [Java Internationalization Guide](#)⁸.

1.5.4. Accessing External Resource Files

Sometimes you may want an annotator to read from an external file – for example, a long list of keys and values that you are going to build into a `HashMap`. You could, of course, just introduce a configuration parameter that holds the absolute path to this resource file, and build the `HashMap` in your annotator's `initialize` method. However, this is not the best solution for three reasons:

1. Including an absolute path in your descriptor makes your annotator difficult for others to use. Each user will need to edit this descriptor and set the absolute path to a value appropriate for his or her installation.
2. You cannot share the `HashMap` between multiple annotators. Also, in some deployment scenarios there may be more than one instance of your annotator, and you would like to have the option for them to use the same `HashMap` instance.
3. Your annotator would become dependent on a particular data representation – the word list would have to come from a file on the local disk and it would have to be in a particular format. It would be better if this were decoupled.

A better way to access external resources is through the `ResourceManager` component. In this section we are going to show an example of how to use the `Resource Manager`.

This example annotator will annotate UIMA acronyms (e.g. UIMA, AE, CAS, JCas) and store the acronym's expanded form as a feature of the annotation. The acronyms and their expanded forms are stored in an external file.

First, look at the `examples/descriptors/tutorial/ex6/UimaAcronymAnnotator.xml` descriptor.

⁸ <http://java.sun.com/j2se/1.5.0/docs/guide/intl/index.html>

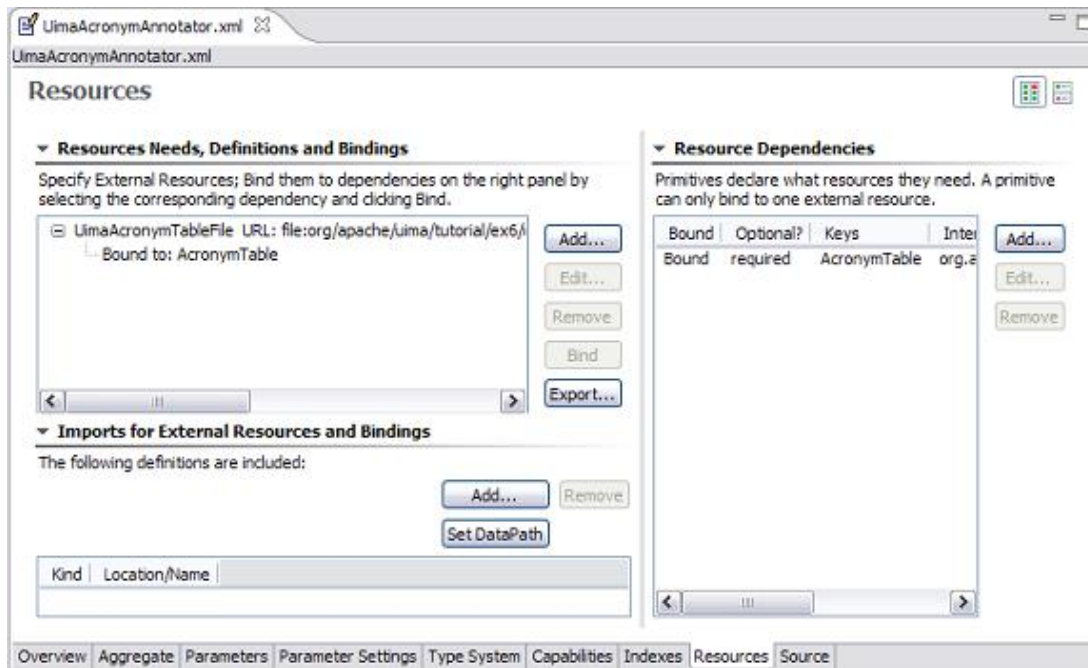

The values of the rows in the two tables are longer than can be easily shown. You can click the small button at the top right to shift the layout from two side-by-side tables, to a vertically stacked layout. You can also click the small twisty on the “Imports for External Resources and Bindings” to collapse this section, because it's not used here. Then the same screen will appear like this:

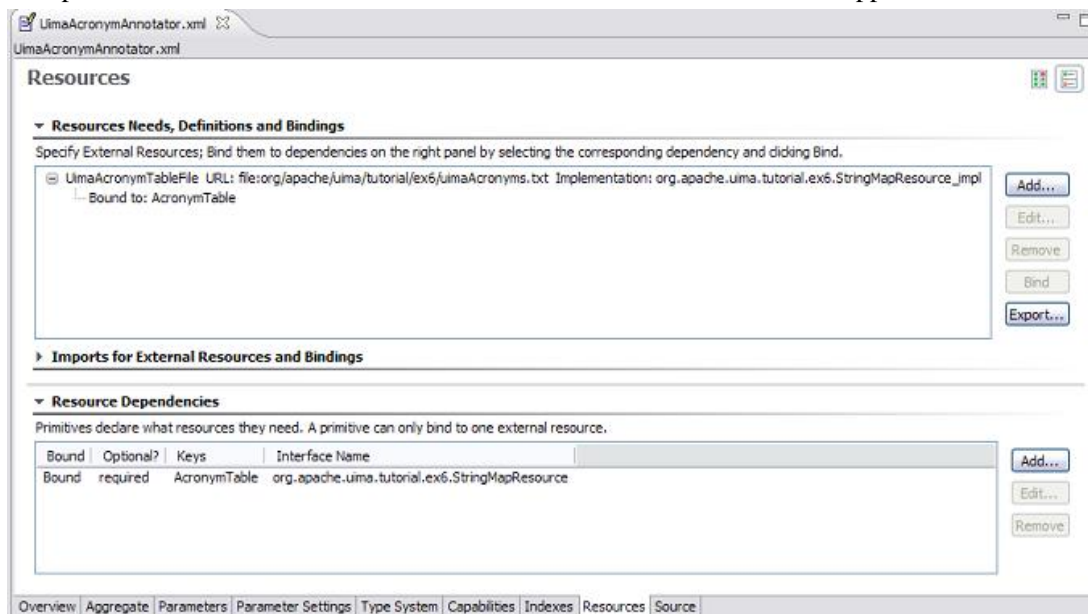

The top window has a scroll bar allowing you to see the rest of the line.

1.5.4.1. Declaring Resource Dependencies

The bottom window is where an annotator declares an external resource dependency. The XML for this is as follows:

```
<externalResourceDependency>
```

```
<key>AcronymTable</key>
<description>Table of acronyms and their expanded forms.</description>
<interfaceName>
  org.apache.uima.tutorial.ex6.StringMapResource
</interfaceName>
</externalResourceDependency>
```

The `<key>` value (`AcronymTable`) is the name by which the annotator identifies this resource. The key must be unique for all resources that this annotator accesses, but the same key could be used by different annotators to mean different things. The interface name (`org.apache.uima.tutorial.ex6.StringMapResource`) is the Java interface through which the annotator accesses the data. Specifying an interface name is optional. If you do not specify an interface name, annotators will get direct access to the data file.

1.5.4.2. Accessing the Resource from the UimaContext

If you look at the `org.apache.uima.tutorial.ex6.UimaAcronymAnnotator` source, you will see that the annotator accesses this resource from the `UimaContext` by calling:

```
StringMapResource mMap =
  (StringMapResource)getContext().getResourceObject("AcronymTable");
```

The object returned from the `getResourceObject` method will implement the interface declared in the `<interfaceName>` section of the descriptor, `StringMapResource` in this case. The annotator code does not need to know the location of the data nor the Java class that is being used to read the data and implement the `StringMapResource` interface.

Note that if we did not specify a Java interface in our descriptor, our annotator could directly access the resource data as follows:

```
InputStream stream = getContext().getResourceAsStream("AcronymTable");
```

If necessary, the annotator could also determine the location of the resource file, by calling:

```
URI uri = getContext().getResourceURI("AcronymTable");
```

These last two options are only available in the case where the descriptor does not declare a Java interface.

Note: The methods for getting access to resources include `getResourceURL`. That method returns a URL, which may contain spaces encoded as `%20`. `url.getPath()` would return the path without decoding these `%20` into spaces. `getResourceURI` on the other hand, returns a URI, and the `uri.getPath()` *does* do the conversion of `%20` into spaces. See also `getResourceFilePath`, which does a `getResourceURI` followed by `uri.getPath()`.

1.5.4.3. Declaring Resources and Bindings

Refer back to the top window in the Resources page of the Component Descriptor Editor. This is where we specify the location of the resource data, and the Java class used to read the data. For the example, this corresponds to the following section of the descriptor:

```
<resourceManagerConfiguration>
  <externalResources>
    <externalResource>
```

```

<name>UimaAcronymTableFile</name>
<description>
  A table containing UIMA acronyms and their expanded forms.
</description>
<fileResourceSpecifier>
  <fileUrl>file:org/apache/uima/tutorial/ex6/uimaAcronyms.txt
  </fileUrl>
</fileResourceSpecifier>
<implementationName>
  org.apache.uima.tutorial.ex6.StringMapResource_impl
</implementationName>
</externalResource>
</externalResources>

<externalResourceBindings>
  <externalResourceBinding>
    <key>AcronymTable</key>
    <resourceName>UimaAcronymTableFile</resourceName>
  </externalResourceBinding>
</externalResourceBindings>
</resourceManagerConfiguration>

```

The first section of this XML declares an `externalResource`, the `UimaAcronymTableFile`. With this, the `fileUrl` element specifies the path to the data file. This can be an absolute URL (e.g. one that starts with `file:/` or `file:///`, or `file://my.host.org/`), but that is not recommended because it makes installation of your component more difficult, as noted earlier. Better is a relative URL, which will be looked up within the classpath (and/or datapath), as used in this example. In this case, the file `org/apache/uima/tutorial/ex6/uimaAcronyms.txt` is located in `uimaj-examples.jar`, which is in the classpath. If you look in this file you will see the definitions of several UIMA acronyms.

The second section of the XML declares an `externalResourceBinding`, which connects the key `AcronymTable`, declared in the annotator's external resource dependency, to the actual resource name `UimaAcronymTableFile`. This is rather trivial in this case; for more on bindings see the example `UimaMeetingDetectorAE.xml` below. There is no global repository for external resources; it is up to the user to define each resource needed by a particular set of annotators.

In the Component Descriptor Editor, bindings are indicated below the external resource. To create a new binding, you select an external resource (which must have previously been defined), and an external resource dependency, and then click the `Bind` button, which only enables if you have selected two things to bind together.

When the Analysis Engine is initialized, it creates a single instance of `StringMapResource_impl` and loads it with the contents of the data file. This means that the framework calls the instance's `load` method, passing it an instance of `DataResource`, from which you can obtain a stream or URI/URL of the external resource that was declared in the external resource; for resources where loading does not make sense, you can implement a `load` method which ignores its argument and just returns. See the Javadocs for `SharedResourceObject` for details on this. The `UimaAcronymAnnotator` then accesses the data through the `StringMapResource` interface. This single instance could be shared among multiple annotators, as will be explained later. Because of this, you should insure your implementation is thread-safe, as it could be called multiple times on multiple threads.

Note that all resource implementation classes (e.g. `StringMapResource_impl` in the provided example) must be declared `public` must not be declared `abstract`, and must have `public`, 0-argument constructors, so that they can be instantiated by the framework. (Although Java classes in which you do not define any constructor will, by default, have a 0-argument constructor that doesn't

do anything, a class in which you have defined at least one constructor does not get a default 0-argument constructor.)

All resource implementation classes that provide access to resource data must also implement the interface `org.apache.uima.resource.SharedResourceObject`. The UIMA Framework will invoke this interface's only method, `load`, after this object has been instantiated. The implementation of this method can then read data from the specified `DataResource` and use that data to initialize this object.

This annotator is illustrated in [Figure 1.3, “External Resource Binding”](#) [33]. To see it in action, just run it using the Document Analyzer. When it finishes, open up the UIMA_Seminars document in the processed results window, (double-click it), and then left-click on one of the highlighted terms, to see the `expandedForm` feature's value.

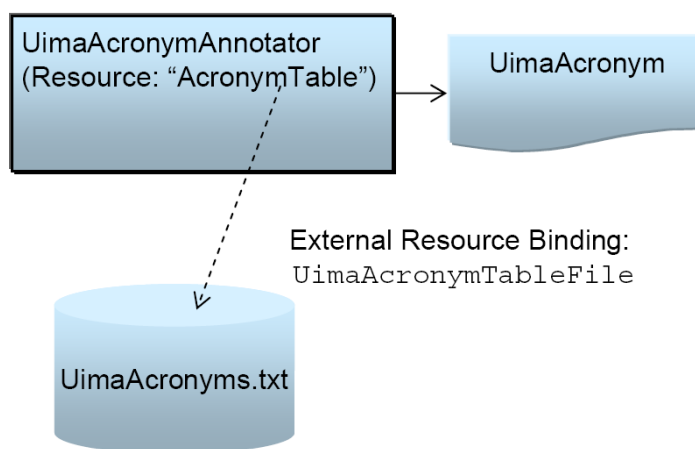

Figure 1.3. External Resource Binding

By designing our annotator in this way, we have gained some flexibility. We can freely replace the `StringMapResource_impl` class with any other implementation that implements the simple `StringMapResource` interface. (For example, for very large resources we might not be able to have the entire map in memory.) We have also made our external resource dependencies explicit in the descriptor, which will help others to deploy our annotator.

1.5.4.4. Sharing Resources among Annotators

Another advantage of the Resource Manager is that it allows our data to be shared between annotators. To demonstrate this we have developed another annotator that will use the same acronym table. The `UimaMeetingAnnotator` will iterate over `Meeting` annotations discovered by the `Meeting Detector` we previously developed and attempt to determine whether the topic of the meeting is related to UIMA. It will do this by looking for occurrences of UIMA acronyms in close proximity to the meeting annotation. We could implement this by using the `UimaAcronymAnnotator`, of course, but for the sake of this example we will have the `UimaMeetingAnnotator` access the acronym map directly.

The Java code for the `UimaMeetingAnnotator` in example 6 creates a new type, `UimaMeeting`, if it finds a meeting within 50 characters of the UIMA acronym.

We combine three analysis engines, the `UimaAcronymAnnotator` to annotate UIMA acronyms, the `MeetingDetector` from example 4 to find meetings and finally the `UimaMeetingAnnotator` to annotate just meetings about UIMA. Together these are assembled to form the new aggregate analysis engine, `UimaMeetingDetector`. This aggregate and the sharing of a common resource are illustrated in [Figure 1.4, “Component engines of an aggregate share a common resource”](#) [34].

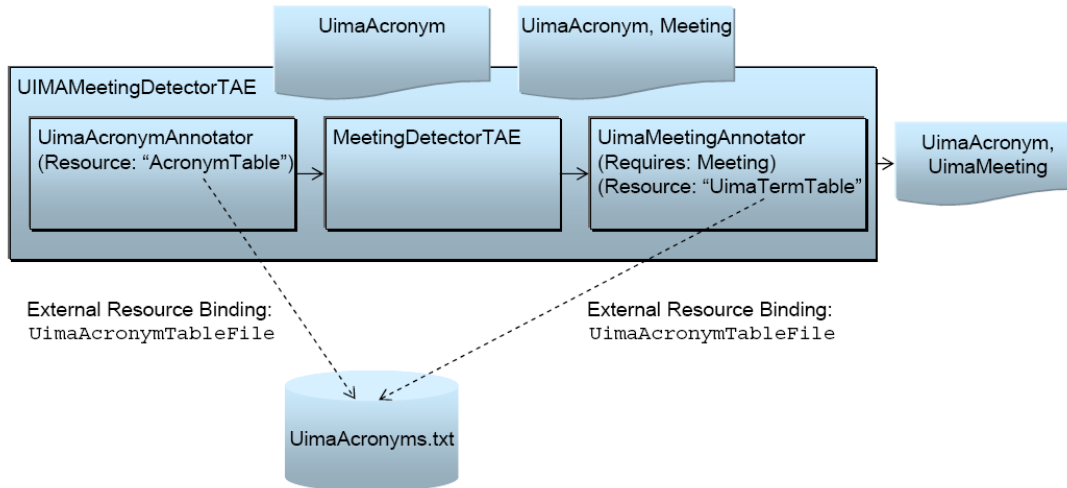
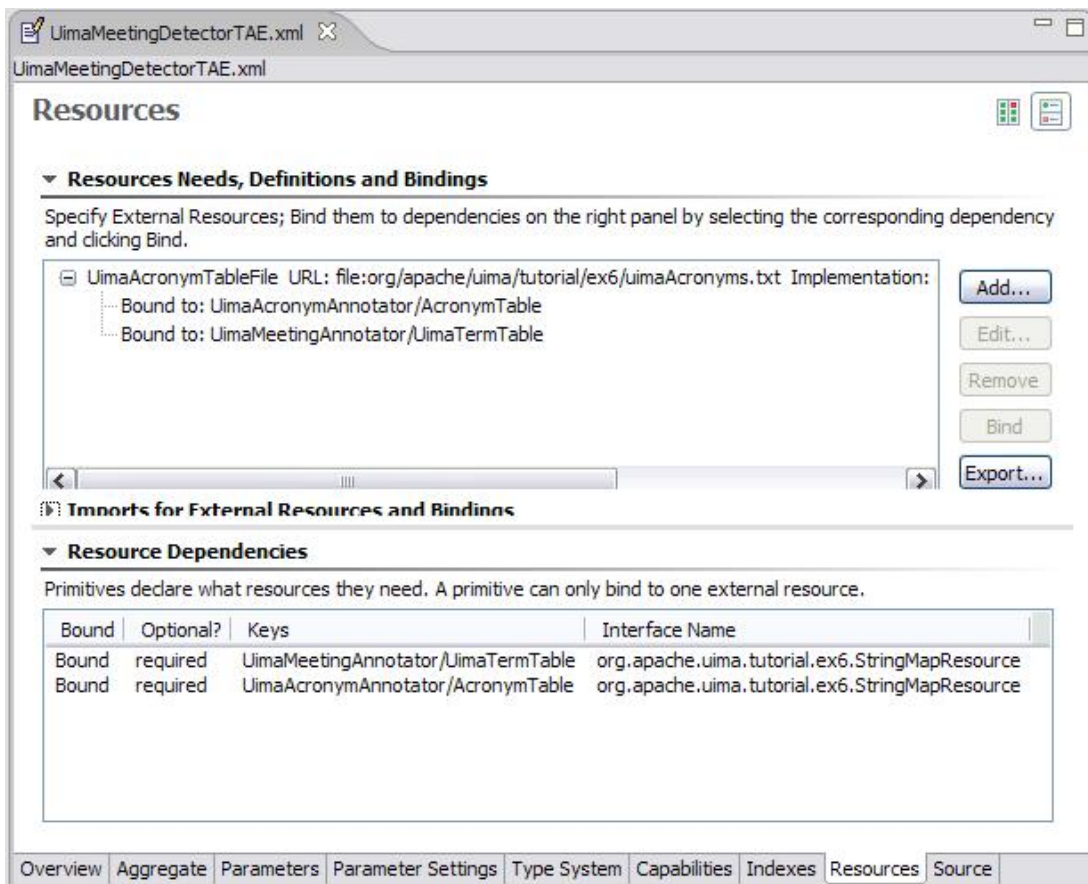

Figure 1.4. Component engines of an aggregate share a common resource

The important thing to notice is in the `UimaMeetingDetectorAE.xml` aggregate descriptor. It includes both the `UimaMeetingAnnotator` and the `UimaAcronymAnnotator`, and contains a single declaration of the `UimaAcronymTableFile` resource. (The actual example has the order of the first two annotators reversed versus the above picture, which is OK since they do not depend on one another).

It also binds the resources as follows:



```
<externalResourceBindings>
  <externalResourceBinding>
    <key>UimaAcronymAnnotator/AcronymTable</key>
    <resourceName>UimaAcronymTableFile</resourceName>
  </externalResourceBinding>

  <externalResourceBinding>
    <key>UimaMeetingAnnotator/UimaTermTable</key>
    <resourceName>UimaAcronymTableFile</resourceName>
  </externalResourceBinding>
</externalResourceBindings>
```

This binds the resource dependencies of both the UimaAcronymAnnotator (which uses the name AcronymTable) and UimaMeetingAnnotator (which uses UimaTermTable) to the single declared resource named UimaAcronymFile. Therefore they will share the same instance. Resource bindings in the aggregate descriptor *override* any resource declarations in individual annotator descriptors.

If we wanted to have the annotators use different acronym tables, we could easily do that. We would simply have to change the resourceName elements in the bindings so that they referred to two different resources. The Resource Manager gives us the flexibility to make this decision at deployment time, without changing any Java code.

1.5.4.5. Threading and Shared Resources

Sharing can also occur when multiple instances of an annotator are created by the framework in response to run-time deployment specifications. If an implementation class is specified in the external resource, only one instance of that implementation class is created for a given binding, and is shared among all annotators. Because of this, the implementation of that shared instance must be written to be thread-safe - that is, to operate correctly when called at arbitrary times by multiple threads. Writing thread-safe code in Java is addressed in several books, such as Brian Goetz's *Java Concurrency in Practice*.

If no implementation class is specified, then the getResource method returns a DataResource object, from which each annotator instance can obtain their own (non-shared) input stream; so threading is not an issue in this case.

1.5.5. Result Specifications

The Result Specification is passed to the annotator instance by calling its setResultSpecification method. When called, the default implementation saves the result specification in an instance variable of the Annotator instance, which can be accessed by the annotator using the protected getResultSpecification() method.

A Result Specification is a list of output types and / or type:feature names, categorized by language(s), which are expected to be output from (produced by) the annotator. Annotators may use this to optimize their operations, when possible, for those cases where only particular outputs are wanted. The interface to the Result Specification object (see the Javadocs) allows querying both types and particular features of types.

The languages specifications used by Result Specifications are the same that are specifiable in Capability Specifications; examples include "en" for English, "en-uk" for British English, etc. There is also a language type, "x-unspecified", which is presumed if no language specification(s) are given.

Result Specifications can be queried by the Annotator code, and the query may include the language. If it doesn't include the language, it is treated as if the language "x-unspecified" was

specified. Language matching is hierarchically defaulted, in one direction: if a query asks about a type T for language "en-uk", it will match for languages "en-uk", "en", or "x-unspecified". However the reverse is not true: If the query asks about a type T for language "x-unspecified", then it only matches Result Specifications with no language (or "x-unspecified", which is equivalent).

The effect of this is that if the Result Specification indicates it wants output produced for "en-uk", but the annotator is given a language which is unknown, or one that is known, but isn't "en-uk", then the query (using the language of the document) will return false. This is true even if the language is "en". However, if the Result Specification indicates it wants output for "en", and the query is for "en-uk" (presumably because that's the language of the document and the annotator can handle that especially well), then the query will return true.

Sometimes you can specify the Result Specification; othertimes, you cannot (for instance, inside a Collection Processing Engine, you cannot). When you cannot specify it, or choose not to specify it (for example, using the form of the `process(...)` call on an Analysis Engine that doesn't include the Result Specification), a "Default" Result Specification is used.

1.5.5.1. Default ResultSpecification

The default Result Specification is taken from the Engine's output Capability Specification. Remember that a Capability Specification has both inputs and outputs, can specify types and / or features, and there can be more than one Capability Set. If there is more than one set, the logical union by language of these sets is used. Each set can have a different "language(s)" specified; the default Result Specification will have the outputs by language(s), so that the annotator can query which outputs should be provided for particular languages. The methods to query the Result Specification take a type and (optionally) a feature, and optionally, a language. If the queried type is a subtype of some otherwise matching type in the Result Specification, it will match the query. See the Javadocs for more details on this.

1.5.5.2. Passing Result Specifications to Annotators

If you are not using a Collection Processing Engine, you can specify a Result Specification for your `AnalysisEngine(s)` by calling the `AnalysisEngine.setResultSpecification(ResultSpecification)` method.

It is also possible to pass a Result Specification on each call to `AnalysisEngine.process(CAS, ResultSpecification)`. However, this is not recommended if your Result Specification will stay constant across multiple calls to `process`. In that case it will be more efficient to call `AnalysisEngine.setResultSpecification(ResultSpecification)` only when the Result Specification changes.

For primitive Analysis Engines, whatever Result Specification you pass in is passed along to the annotator's `setResultSpecification(ResultSpecification)` method. For aggregate Analysis Engines, see below.

1.5.5.3. Aggregates

For aggregate engines, the Result Specification passed to the `AnalysisEngine.setResultSpecification(ResultSpecification)` method is intended to specify the set of output types/features that the aggregate should produce. This is not necessarily equivalent to the set of output types/features that each annotator should produce. For example, an annotator may need to produce an intermediate type that is then consumed by a downstream annotator, even though that intermediate type is not part of the Result Specification.

To handle this situation, when

`AnalysisEngine.setResultSpecification(ResultSpecification)` is called on an aggregate, the framework computes the union of the passed Result Specification with the set of *all* input types and features of *all* component AnalysisEngines within that aggregate. This forms the complete set of types and features that any component of the aggregate might need to produce. This derived Result Specification is then passed to the `AnalysisEngine.setResultSpecification(ResultSpecification)` of each component AnalysisEngine. In the case of nested aggregates, this procedure is applied recursively.

1.5.5.4. Collection Processing Engines

The Default Result Specification is always used for all components of a Collection Processing Engine.

1.5.6. Class path setup when using JCas

JCas provides Java classes that correspond to each CAS type in an application. These classes are generated by the JCasGen utility (which can be automatically invoked from the Component Descriptor Editor).

The Java source classes generated by the JCasGen utility are typically compiled and packaged into a JAR file. This JAR file must be present in the classpath of the UIMA application.

For more details on issues around setting up this class path, including deployment issues where class loaders are being used to isolate multiple UIMA applications inside a single running Java Virtual Machine, please see Section 5.6.6, “Class Loaders in UIMA”.

1.5.7. Using the Shell Scripts

The SDK includes a `/bin` subdirectory containing shell scripts, for Windows (.bat files) and Unix (.sh files). Many of these scripts invoke sample Java programs which require a class path; they call a common shell script, `setUimaClassPath` to set up the UIMA required files and directories on the class path.

If you need to include files on the class path, the scripts will add anything you specify in the environment variables `CLASSPATH` or `UIMA_CLASSPATH` to the classpath. So, for example, if you are running the document analyzer, and wanted it to find a Java class file named (on Windows) `c:\a\b\c\myProject\myJarFile.jar`, you could first issue a `set` command to set the `UIMA_CLASSPATH` to this file, followed by the `documentAnalyzer` script:

```
set UIMA_CLASSPATH=c:\a\b\c\myProject\myJarFile.jar
documentAnalyzer
```

Other environment variables are used by the shell scripts, as follows:

Table 1.1. Environment variables used by the shell scripts

Environment Variable	Description
<code>UIMA_HOME</code>	Path where the UIMA SDK was installed.
<code>JAVA_HOME</code>	(Optional) Path to a Java Runtime Environment. If not set, the Java JRE that is in your system <code>PATH</code> is used.

Environment Variable	Description
UIMA_CLASSPATH	(Optional) if specified, a path specification to use as the default ClassPath. You can also set the CLASSPATH variable. If you set both, they will be concatenated.
UIMA_DATAPATH	(Optional) if specified, a path specification to use as the default DataPath (see Section 2.2, “Imports”)
UIMA_LOGGER_CONFIG_FILE	(Optional) if specified, a path to a Java Logger properties file (see Section 1.2, “Configuration and Logging” [13])
UIMA_JVM_OPTS	(Optional) if specified, the JVM arguments to be used when the Java process is started. This can be used for example to set the maximum Java heap size or to define system properties.
VNS_PORT	(Optional) if specified, the network IP port number of the Vinci Name Server (VNS) (see Section 3.6.5, “The Vinci Naming Services (VNS)”)
ECLIPSE_HOME	(Optional) Needs to be set to the root of your Eclipse installation when using shell scripts that invoke Eclipse (e.g. jcasgen_merge)

1.6. Common Pitfalls

Here are some things to avoid doing in your annotator code:

Retaining references to JCas objects between calls to process()

The JCas will be cleared between calls to your annotator's process() method. All of the analysis results related to the previous document will be deleted to make way for analysis of a new document. Therefore, you should never save a reference to a JCas Feature Structure object (i.e. an instance of a class created using JCasGen) and attempt to reuse it in a future invocation of the process() method. If you do so, the results will be undefined.

Careless use of static data

Always keep in mind that an application that uses your annotator may create multiple instances of your annotator class. A multithreaded application may attempt to use two instances of your annotator to process two different documents simultaneously. This will generally not cause any problems as long as your annotator instances do not share static data.

In general, you should not use static variables other than static final constants of primitive data types (String, int, float, etc). Other types of static variables may allow one annotator instance to set a value that affects another annotator instance, which can lead to unexpected effects. Also, static references to classes that aren't thread-safe are likely to cause errors in multithreaded applications.

1.7. Viewing UIMA objects in the Eclipse debugger

Eclipse (as of version 3.1 or later) has a new feature for viewing Java Logical Structures. When enabled, it will permit you to see a view of UIMA objects (such as feature structure instances, CAS or JCas instances, etc.) which displays the logical subparts. For example, here is a view of a feature structure for the RoomNumber annotation, from the tutorial example 1:

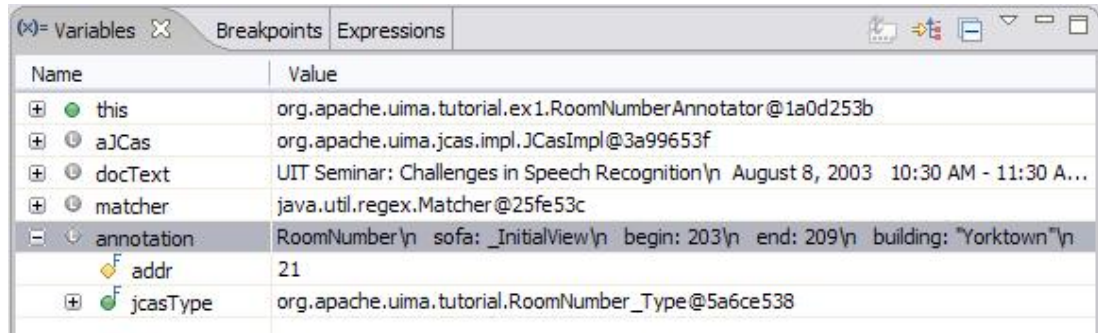

Name	Value	
+	this	org.apache.uima.tutorial.ex1.RoomNumberAnnotator@1a0d253b
+	aJCas	org.apache.uima.jcas.impl.JCasImpl@3a99653f
+	docText	UIT Seminar: Challenges in Speech Recognition\n August 8, 2003 10:30 AM - 11:30 A...
+	matcher	java.util.regex.Matcher@25fe53c
-	annotation	RoomNumber\n sofa: _InitialView\n begin: 203\n end: 209\n building: Yorktown\n
	addr	21
+	jcasType	org.apache.uima.tutorial.RoomNumber_Type@5a6ce538

The “annotation” object in Java shows as a 2 element object, not very convenient for seeing the features or the part of the input that is being annotated. But if you turn on the Java Logical Structure mode by pushing this button:



the features of the FeatureStructure instance will be shown:

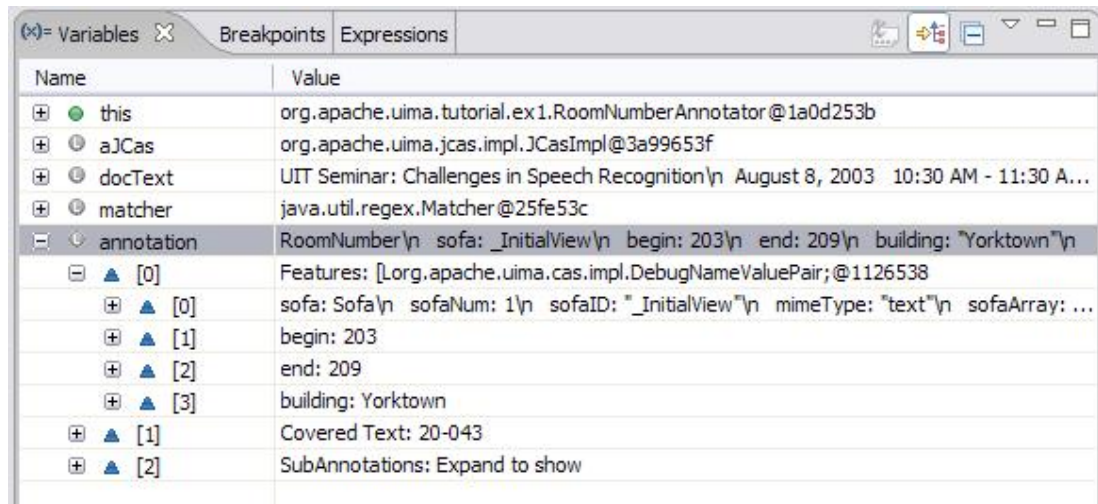

Name	Value	
+	this	org.apache.uima.tutorial.ex1.RoomNumberAnnotator@1a0d253b
+	aJCas	org.apache.uima.jcas.impl.JCasImpl@3a99653f
+	docText	UIT Seminar: Challenges in Speech Recognition\n August 8, 2003 10:30 AM - 11:30 A...
+	matcher	java.util.regex.Matcher@25fe53c
-	annotation	RoomNumber\n sofa: _InitialView\n begin: 203\n end: 209\n building: Yorktown\n
	[0]	Features: [org.apache.uima.cas.impl.DebugNameValuePair;@1126538
	[0]	sofa: Sofa\n sofaNum: 1\n sofaID: "_InitialView"\n mimeType: "text"\n sofaArray: ...
	[1]	begin: 203
	[2]	end: 209
	[3]	building: Yorktown
	[1]	Covered Text: 20-043
	[2]	SubAnnotations: Expand to show

1.8. Introduction to Analysis Engine Descriptor XML Syntax

This section is an introduction to the syntax used for Analysis Engine Descriptors. Most users do not need to understand these details; they can use the Component Descriptor Editor Eclipse plugin to edit Analysis Engine Descriptors rather than editing the XML directly.

This section walks through the actual XML descriptor for the RoomNumberAnnotator example introduced in section [Section 1.1, “Getting Started”](#) [2]. The discussion is divided into several logical sections of the descriptor.

The full specification for Analysis Engine Descriptors is defined in Chapter 2, *Component Descriptor Reference*.

1.8.1. Header and Annotator Class Identification

```
<?xml version="1.0" encoding="UTF-8" ?>
<!-- Descriptor for the example RoomNumberAnnotator. -->
<analysisEngineDescription xmlns="http://uima.apache.org/resourceSpecifier">
  <frameworkImplementation>org.apache.uima.java</frameworkImplementation>
  <primitive>true</primitive>
  <annotatorImplementationName>
    org.apache.uima.tutorial.ex1.RoomNumberAnnotator
  </annotatorImplementationName>
```

The document begins with a standard XML header and a comment. The root element of the document is named `<analysisEngineDescription>`, and must specify the XML namespace `http://uima.apache.org/resourceSpecifier`.

The first subelement, `<frameworkImplementation>`, must contain the value `org.apache.uima.java`. The second subelement, `<primitive>`, contains the Boolean value `true`, indicating that this XML document describes a *Primitive* Analysis Engine. A Primitive Analysis Engine is comprised of a single annotator. It is also possible to construct XML descriptors for non-primitive or *Aggregate* Analysis Engines; this is covered later.

The next element, `<annotatorImplementationName>`, contains the fully-qualified class name of our annotator class. This is how the UIMA framework determines which annotator class to instantiate.

1.8.2. Simple Metadata Attributes

```
<analysisEngineMetaData>
  <name>Room Number Annotator</name>
  <description>An example annotator that searches for room numbers in
    the IBM Watson research buildings.</description>
  <version>1.0</version>
  <vendor>The Apache Software Foundation</vendor></para>
```

Here are shown four simple metadata fields – name, description, version, and vendor. Providing values for these fields is optional, but recommended.

1.8.3. Type System Definition

```
<typeSystemDescription>
  <imports>
    <import location="TutorialTypeSystem.xml" />
  </imports>
</typeSystemDescription>
```

This section of the XML descriptor defines which types the annotator works with. The recommended way to do this is to *import* the type system definition from a separate file, as shown here. The location specified here should be a relative path, and it will be resolved relative to the location of the aggregate descriptor. It is also possible to define types directly in the Analysis Engine descriptor, but these types will not be easily shareable by others.

1.8.4. Capabilities

```
<capabilities>
  <capability>
    <inputs />
    <outputs>
      <type>org.apache.uima.tutorial.RoomNumber</type>
      <feature>org.apache.uima.tutorial.RoomNumber:building</feature>
    </outputs>
  </capability>
</capabilities>
```

The last section of the descriptor describes the *Capabilities* of the annotator – the Types/Features it consumes (input) and the Types/Features that it produces (output). These must be the names of types and features that exist in the ANALYSIS ENGINE descriptor's type system definition.

Our annotator outputs only one Type, RoomNumber and one feature, RoomNumber:building. The fully-qualified names (including namespace) are needed.

The building feature is listed separately here, but clearly specifying every feature for a complex type would be cumbersome. Therefore, a shortcut syntax exists. The <outputs> section above could be replaced with the equivalent section:

```
<outputs>
  <type allAnnotatorFeatures = "true">
    org.apache.uima.tutorial.RoomNumber
  </type>
</outputs>
```

1.8.5. Configuration Parameters (Optional)

1.8.5.1. Configuration Parameter Declarations

```
<configurationParameters>
  <configurationParameter>
    <name>Patterns</name>
    <description>List of room number regular expression patterns.
    </description>
    <type>String</type>
    <multiValued>true</multiValued>
    <mandatory>true</mandatory>
  </configurationParameter>
  <configurationParameter>
    <name>Locations</name>
    <description>List of locations corresponding to the room number
      expressions specified by the Patterns parameter.
    </description>
    <type>String</type>
    <multiValued>true</multiValued>
    <mandatory>true</mandatory>
  </configurationParameter>
</configurationParameters>
```

The <configurationParameters> element contains the definitions of the configuration parameters that our annotator accepts. We have declared two parameters. For each configuration parameter, the following are specified:

- **name** – the name that the annotator code uses to refer to the parameter
- **description** – a natural language description of the intent of the parameter
- **type** – the data type of the parameter's value – must be one of String, Integer, Float, or Boolean.
- **multiValued** – true if the parameter can take multiple-values (an array), false if the parameter takes only a single value.
- **mandatory** – true if a value must be provided for the parameter

Both of our parameters are mandatory and accept an array of Strings as their value.

1.8.5.2. Configuration Parameter Settings

```
<configurationParameterSettings>
  <nameValuePair>
    <name>Patterns</name>
    <value>
      <array>
        <string>b[0-4]d-[0-2]ddb</string>
        <string>b[G1-4][NS]-[A-Z]ddb</string>
        <string>bJ[12]-[A-Z]ddb</string>
      </array>
    </value>
  </nameValuePair>
  <nameValuePair>
    <name>Locations</name>
    <value>
      <array>
        <string>Watson - Yorktown</string>
        <string>Watson - Hawthorne I</string>
        <string>Watson - Hawthorne II</string>
      </array>
    </value>
  </nameValuePair>
</configurationParameterSettings>
```

1.8.5.3. Aggregate Analysis Engine Descriptor

```
<?xml version="1.0" encoding="UTF-8" ?>
<analysisEngineDescription xmlns="http://uima.apache.org/resourceSpecifier">
  <frameworkImplementation>org.apache.uima.java</frameworkImplementation>
  <primitive>>false</primitive>

  <delegateAnalysisEngineSpecifiers>
    <delegateAnalysisEngine key="RoomNumber">
      <import location="../ex2/RoomNumberAnnotator.xml"/>
    </delegateAnalysisEngine>
    <delegateAnalysisEngine key="DateTime">
      <import location="TutorialDateTime.xml" />
    </delegateAnalysisEngine>
  </delegateAnalysisEngineSpecifiers>
```

The first difference between this descriptor and an individual annotator's descriptor is that the `<primitive>` element contains the value `false`. This indicates that this Analysis Engine (AE) is an aggregate AE rather than a primitive AE.

Then, instead of a single annotator class name, we have a list of `delegateAnalysisEngineSpecifiers`. Each specifies one of the components that constitute our Aggregate. We refer to each component by the relative path from this XML descriptor to the component AE's XML descriptor.

This list of component AEs does not imply an ordering of them in the execution pipeline. Ordering is done by another section of the descriptor:

```
<analysisEngineMetaData>
  <name>Aggregate AE - Room Number and DateTime Annotators</name>
  <description>Detects Room Numbers, Dates, and Times</description>
  <flowConstraints>
    <fixedFlow>
      <node>RoomNumber</node>
      <node>DateTime</node>
    </fixedFlow>
  </flowConstraints>
```

Here, a `fixedFlow` is adequate, and we specify the exact ordering in which the AEs will be executed. In this case, it doesn't really matter, since the `RoomNumber` and `DateTime` annotators do not have any dependencies on one another.

Finally, the descriptor has a `capabilities` section, which has exactly the same syntax as a primitive AE's `capabilities` section:

```
<capabilities>
  <capability>
    <inputs />
    <outputs>
      <type allAnnotatorFeatures="true">
        org.apache.uima.tutorial.RoomNumber
      </type>
      <type allAnnotatorFeatures="true">
        org.apache.uima.tutorial.DateAnnot
      </type>
      <type allAnnotatorFeatures="true">
        org.apache.uima.tutorial.TimeAnnot
      </type>
    </outputs>
    <languagesSupported>
      <language>en</language>
    </languagesSupported>
  </capability>
</capabilities>
```

Chapter 2. Collection Processing Engine Developer's Guide

The UIMA Analysis Engine interface provides support for developing and integrating algorithms that analyze unstructured data. Analysis Engines are designed to operate on a per-document basis. Their interface handles one CAS at a time. UIMA provides additional support for applying analysis engines to collections of unstructured data with its *Collection Processing Architecture*. The Collection Processing Architecture defines additional components for reading raw data formats from data collections, preparing the data for processing by Analysis Engines, executing the analysis, extracting analysis results, and deploying the overall flow in a variety of local and distributed configurations.

The functionality defined in the Collection Processing Architecture is implemented by a *Collection Processing Engine* (CPE). A CPE includes an Analysis Engine and adds a *Collection Reader*, a *CAS Initializer* (deprecated as of version 2), and *CAS Consumers*. The part of the UIMA Framework that supports the execution of CPEs is called the Collection Processing Manager, or CPM.

A Collection Reader provides the interface to the raw input data and knows how to iterate over the data collection. Collection Readers are discussed in [Section 2.4.1, “Developing Collection Readers”](#) [52]. The CAS Initializer¹ prepares an individual data item for analysis and loads it into the CAS. CAS Initializers are discussed in [Section 2.4.2, “Developing CAS Initializers”](#) [58]. A CAS Consumer extracts analysis results from the CAS and may also perform *collection level processing*, or analysis over a collection of CASes. CAS Consumers are discussed in [Section 2.4.3, “Developing CAS Consumers”](#) [58].

Analysis Engines and CAS Consumers are both instances of *CAS Processors*. A Collection Processing Engine (CPE) may contain multiple CAS Processors. An Analysis Engine contained in a CPE may itself be a Primitive or an Aggregate (composed of other Analysis Engines). Aggregates may contain CAS Consumers. While Collection Readers and CAS Initializers always run in the same JVM as the CPM, a CAS Processor may be deployed in a variety of local and distributed modes, providing a number of options for scalability and robustness. The different deployment options are covered in detail in [Section 2.5, “Deploying a CPE”](#) [61].

Each of the components in a CPE has an interface specified by the UIMA Collection Processing Architecture and is described by a declarative XML descriptor file. Similarly, the CPE itself has a well defined component interface and is described by a declarative XML descriptor file.

A user creates a CPE by assembling the components mentioned above. The UIMA SDK provides a graphical tool, called the CPE Configurator, for assisting in the assembly of CPEs. Use of this tool is summarized in [Section 2.2.1, “Using the CPE Configurator”](#) [47], and more details can be found in Chapter 2, *Collection Processing Engine Configurator User's Guide*. Alternatively, a CPE can be assembled by writing an XML CPE descriptor. Details on the CPE descriptor, including its syntax and content, can be found in the Chapter 3, *Collection Processing Engine Descriptor Reference*. The individual components have associated XML descriptors, each of which can be created and / or edited using the Component Description Editor.

A CPE is executed by a UIMA infrastructure component called the *Collection Processing Manager* (CPM). The CPM provides a number of services and deployment options that cover instantiation and execution of CPEs, error recovery, and local and distributed deployment of the CPE components.

¹CAS Initializers are deprecated in favor of a more general mechanism, multiple subjects of analysis.

2.1. CPE Concepts

Figure 2.1, “CPE Components” [46] illustrates the data flow that occurs between the different types of components that make up a CPE.

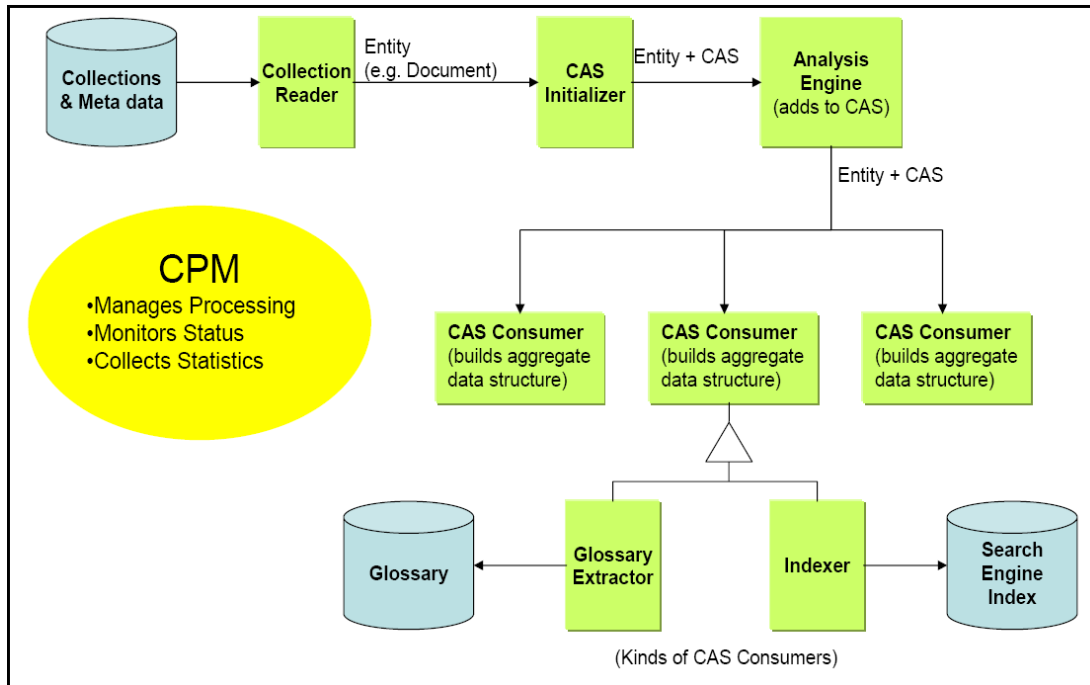

Figure 2.1. CPE Components

The components of a CPE are:

- *Collection Reader* – interfaces to a collection of data items (e.g., documents) to be analyzed. Collection Readers return CASes that contain the documents to analyze, possibly along with additional metadata.
- *Analysis Engine* – takes a CAS, analyzes its contents, and produces an enriched CAS. Analysis Engines can be recursively composed of other Analysis Engines (called an *Aggregate Analysis Engine*). Aggregates may also contain CAS Consumers.
- *CAS Consumer* – consume the enriched CAS that was produced by the sequence of Analysis Engines before it, and produce an application-specific data structure, such as a search engine index or database.

A fourth type of component, the *CAS Initializer*, may be used by a Collection Reader to populate a CAS from a document. However, as of UIMA version 2 CAS Initializers are now deprecated in favor of a more general mechanism, multiple Subjects of Analysis.

The Collection Processing Manager orchestrates the data flow within a CPE, monitors status, optionally manages the life-cycle of internal components and collects statistics.

CASes are not saved in a persistent way by the framework. If you want to save CASes, then you have to save each CAS as it comes through (for example) using a CAS Consumer you write to do this, in whatever format you like. The UIMA SDK supplies an example CAS Consumer to save CASes to XML files, either in the standard XMI format or in an older format called XCAS. It also supplies an example CAS Consumer to extract information from CASes and store the results into a relational Database, using Java's JDBC APIs.

2.2. CPE Configurator and CAS viewer

2.2.1. Using the CPE Configurator

A CPE can be assembled by writing an XML CPE descriptor. Details on the CPE descriptor, including its syntax and content, can be found in Chapter 3, *Collection Processing Engine Descriptor Reference*. Rather than edit raw XML, you may develop a CPE Descriptor using the CPE Configurator tool. The CPE Configurator tool is described briefly in this section, and in more detail in Chapter 2, *Collection Processing Engine Configurator User's Guide*.

The CPE Configurator tool can be run from Eclipse (see [Section 2.2.2, “Running the CPE Configurator from Eclipse” \[51\]](#)), or using the `cpeGui` shell script (`cpeGui.bat` on Windows, `cpeGui.sh` on Unix), which is located in the `bin` directory of the UIMA SDK installation. Executing this batch file will display the window shown here:

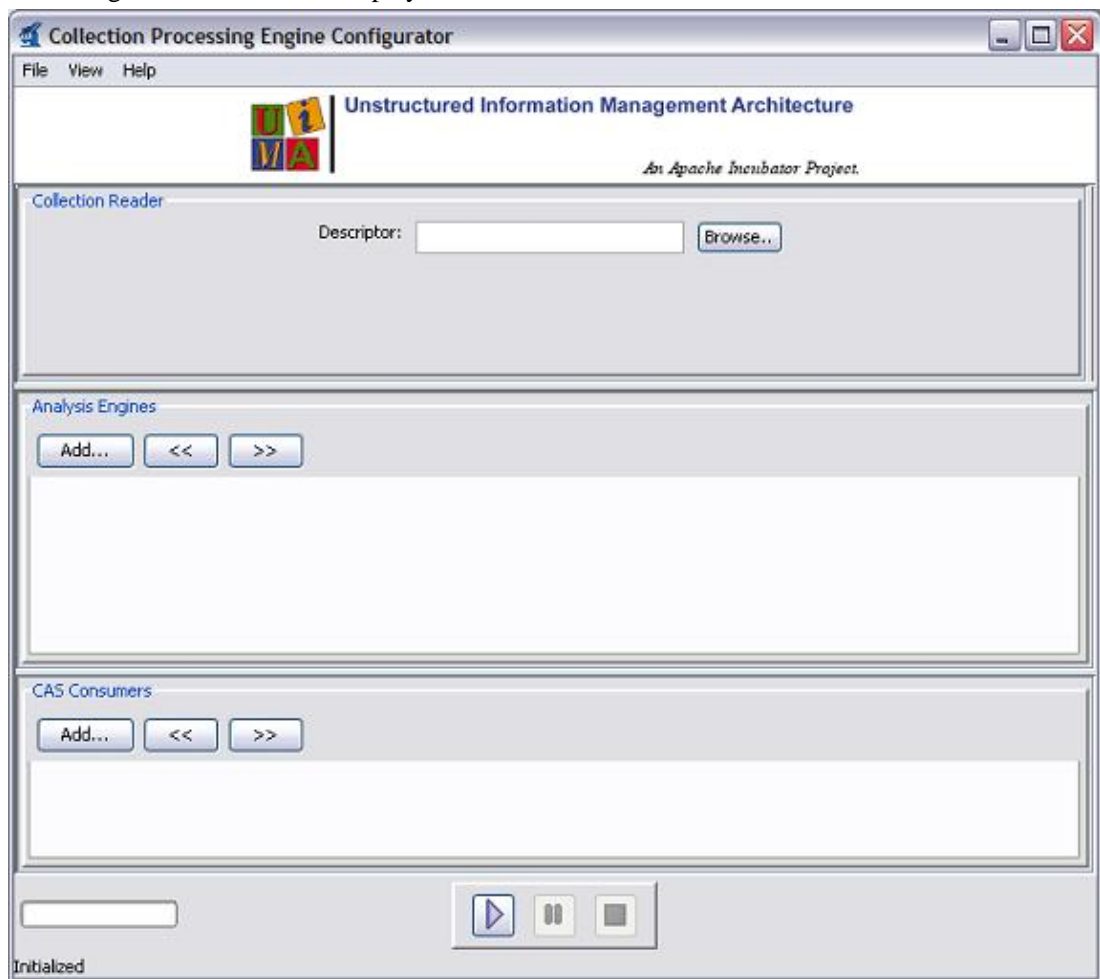

The window is divided into three sections, one each for the Collection Reader, Analysis Engines, and CAS Consumers.² In each section, you select the component(s) you want to include in the CPE by browsing to their XML descriptors. The configuration parameters present in the XML descriptors will then be displayed in the GUI; these can be modified to override the values present

²There is also a fourth pane, for the CAS Initializer, but it is hidden by default. To enable it click the `View → CAS Initializer Panel` menu item.

in the descriptor. For example, the screen shot below shows the CPE Configurator after the following components have been chosen:

```
Collection Reader:
  %UIMA_HOME%/examples/descriptors/collection_reader/
  FileSystemCollectionReader.xml

Analysis Engine:
  %UIMA_HOME%/examples/descriptors/analysis_engine/
  NamesAndPersonTitles_TAE.xml

CAS Consumer:
  %UIMA_HOME%/examples/descriptors/cas_consumer/
  XmiWriterCasConsumer.xml
```

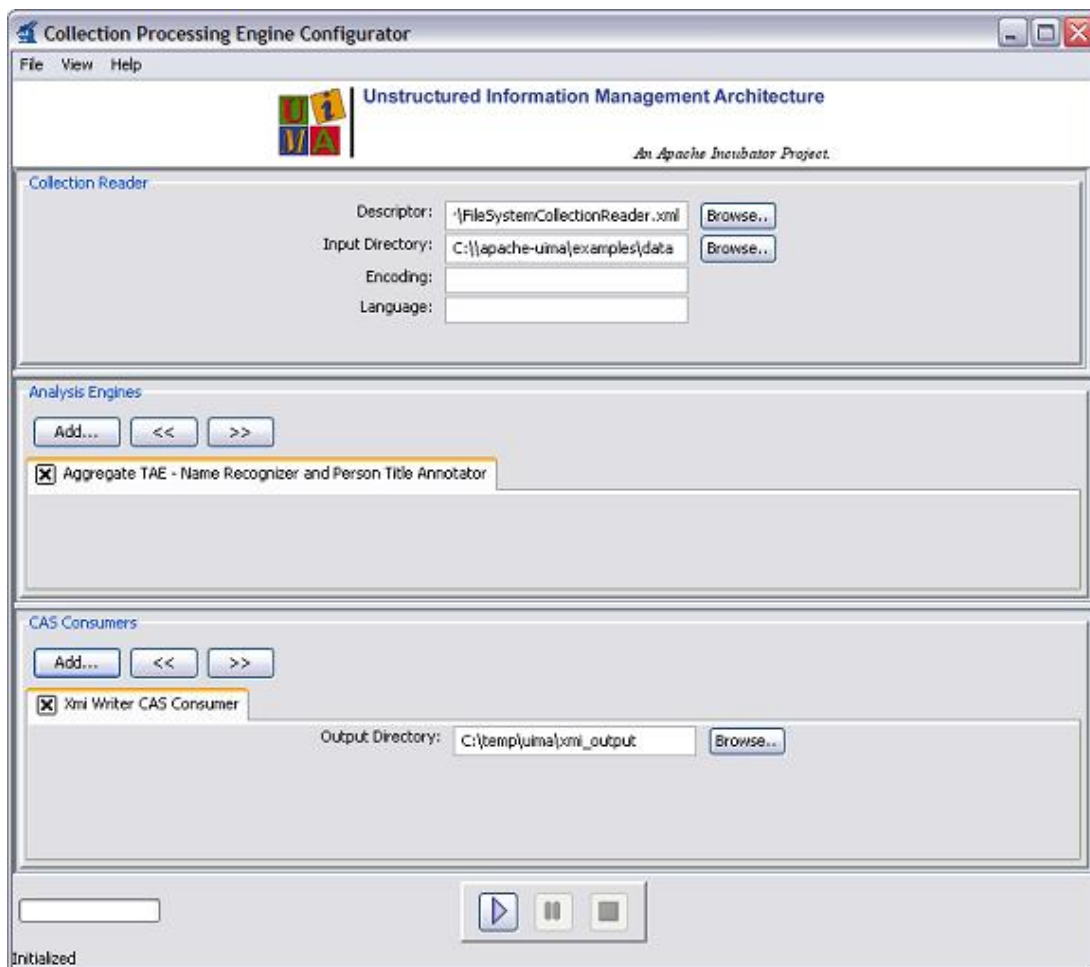

For the File System Collection Reader, ensure that the Input Directory is set to %UIMA_HOME%\examples\data³. The other parameters may be left blank. For the External CAS Writer CAS Consumer, ensure that the Output Directory is set to %UIMA_HOME%\examples\data\processed.

After selecting each of the components and providing configuration settings, click the play (forward arrow) button at the bottom of the screen to begin processing. A progress bar should

³Replace %UIMA_HOME% with the path to where you installed UIMA.

be displayed in the lower left corner. (Note that the progress bar will not begin to move until all components have completed their initialization, which may take several seconds.) Once processing has begun, the pause and stop buttons become enabled.

If an error occurs, you will be informed by an error dialog. If processing completes successfully, you will be presented with a performance report.

Using the File menu, you can select `Save CPE Descriptor` to create an .xml descriptor file that defines the CPE you have constructed. Later, you can use `Open CPE Descriptor` to restore the CPE Configurator to the saved state. Also, CPE descriptors can be used to run a CPE from a Java program – see section [Section 2.3, “Running a CPE from Your Own Java Application”](#) [51]. CPE Descriptors allow specifying operational parameters, such as error handling options, that are not currently available for configuration through the CPE Configurator. For more information on manually creating a CPE Descriptor, see the Chapter 3, *Collection Processing Engine Descriptor Reference*.

The CPE configured above runs a simple name and title annotator on the sample data provided with the UIMA SDK and stores the results using the XMI Writer CAS Consumer. To view the results, start the External CAS Annotation Viewer by running the `annotationViewer` batch file (`annotationViewer.bat` on Windows, `annotationViewer.sh` on Unix), which is located in the `bin` directory of the UIMA SDK installation. Executing this batch file will display the window shown here:

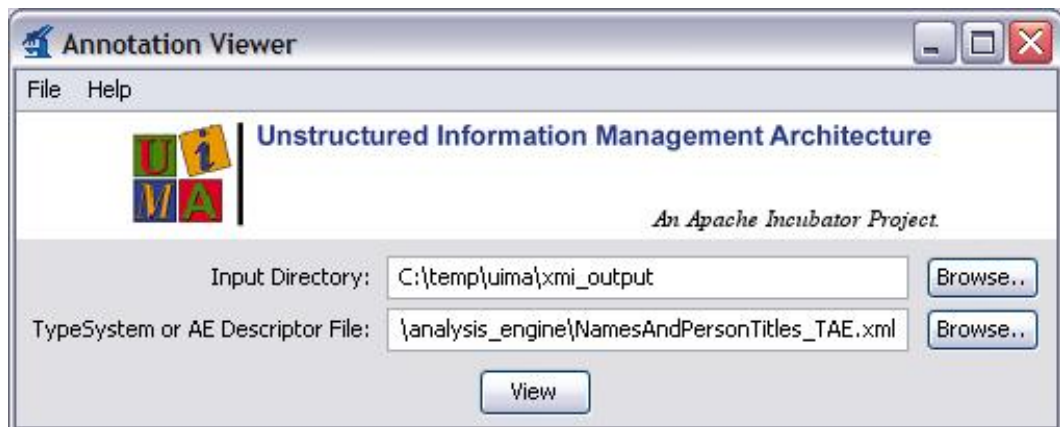

Ensure that the Input Directory is the same as the Output Directory specified for the XMI Writer CAS Consumer in the CPE configured above (e.g., `%UIMA_HOME%\examples\data\processed`) and that the TAE Descriptor File is set to the Analysis Engine used in the CPE configured above (e.g., `examples\descriptors\analysis_engine\NamesAndPersonTitles_TAE.xml`).

Click the View button to display the Analyzed Documents window:

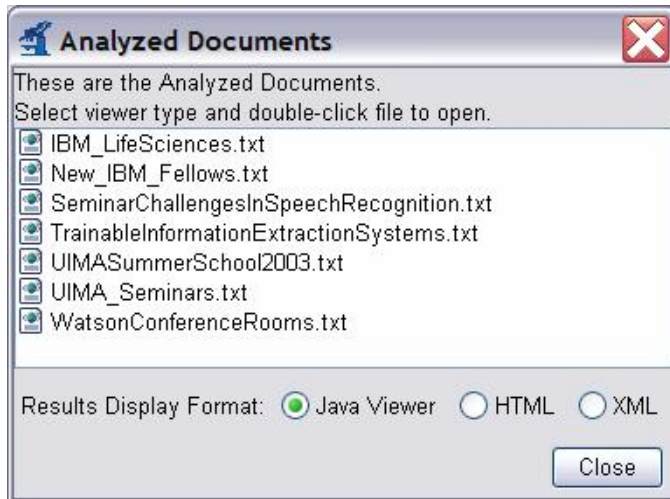

Double click on any document in the list to view the analyzed document. Double clicking the first document, `IBM_LifeSciences.txt`, will bring up the following window:

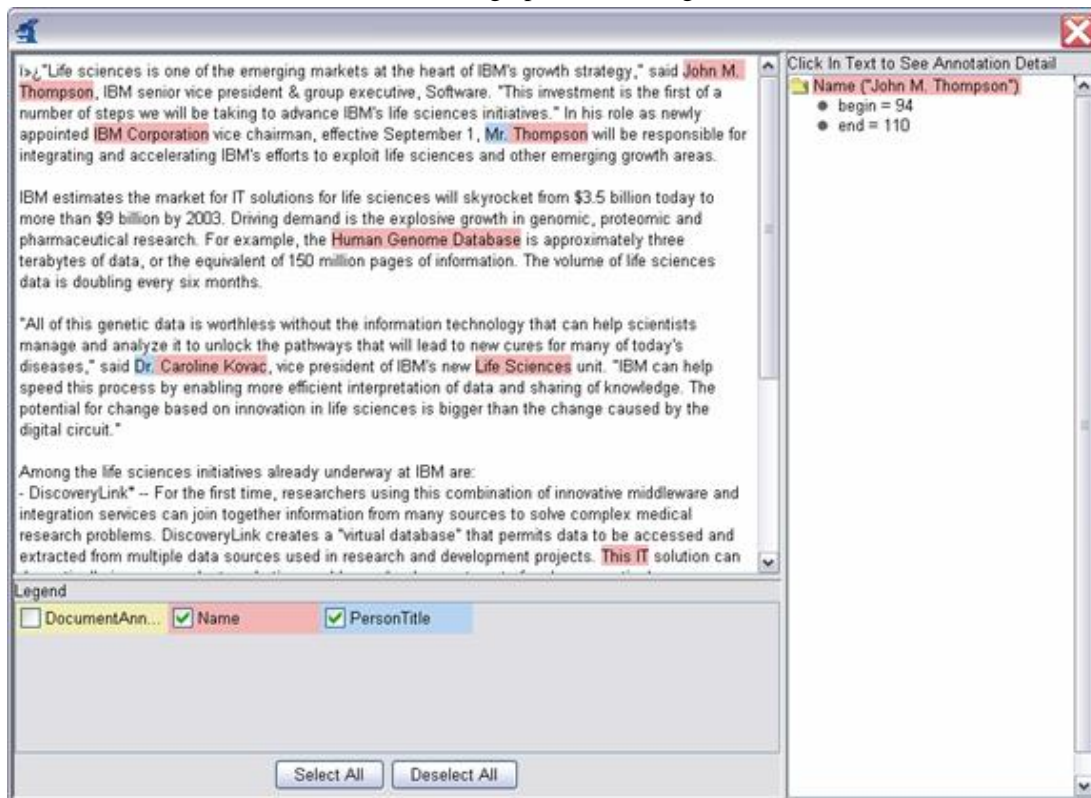

This window shows the analysis results for the document. Clicking on any highlighted annotation causes the details for that annotation to be displayed in the right-hand pane. Here the annotation spanning “John M. Thompson” has been clicked.

Congratulations! You have successfully configured a CPE, saved its descriptor, run the CPE, and viewed the analysis results.

2.2.2. Running the CPE Configurator from Eclipse

If you have followed the instructions in Chapter 3, *Setting up the Eclipse IDE to work with UIMA* and imported the example Eclipse project, then you should already have a Run configuration for the CPE Configurator tool (called `UIMA_CPE_GUI`) configured to run in the example project. Simply run that configuration to start the CPE Configurator.

If you haven't followed the Eclipse setup instructions and wish to run the CPE Configurator tool from Eclipse, you will need to do the following. As installed, this Eclipse launch configuration is associated with the "uimaj-examples" project. If you've not already done so, you may wish to import that project into your Eclipse workspace. It's located in `%UIMA_HOME%/docs/examples`. Doing this will supply the Eclipse launcher with all the class files it needs to run the CPE configurator. If you don't do this, please manually add the JAR files for UIMA to the launch configuration.

Also, you need to add any projects or JAR files for any UIMA components you will be running to the launch class path.

Note: A simpler alternative may be to change the CPE launch configuration to be based on your project. If you do that, it will pick up all the files in your project's class path, which you should set up to include all the UIMA framework files. An easy way to do this is to specify in your project's properties' build-path that the uimaj-examples project is on the build path, because the uimaj-examples project is set up to include all the UIMA framework classes in its classpath already.

Next, in the Eclipse menu select `Run → Run...`, which brings up the Run configuration screen.

In the Main tab, set the main class to `org.apache.uima.tools.cpm.CpmFrame`

In the arguments tab, add the following to the VM arguments:

```
-Xms128M -Xmx256M
-Duima.home="C:\Program Files\Apache\uima"
```

(or wherever you installed the UIMA SDK)

Click the Run button to launch the CPE Configurator, and use it as previously described in this section.

2.3. Running a CPE from Your Own Java Application

The simplest way to run a CPE from a Java application is to first create a CPE descriptor as described in the previous section. Then the CPE can be instantiated and run using the following code:

```
//parse CPE descriptor in file specified on command line
CpeDescription cpeDesc = UIMAFramework.getXMLParser().
    parseCpeDescription(new XMLInputSource(args[0]));

//instantiate CPE
mCPE = UIMAFramework.produceCollectionProcessingEngine(cpeDesc);
```

```
//Create and register a Status Callback Listener
mCPE.addStatusCallbackListener(new StatusCallbackListenerImpl());

//Start Processing
mCPE.process();
```

This will start the CPE running in a separate thread.

Note: The `process()` method for a CPE can only be called once. If you need to call it again, you have to instantiate a new CPE, and call that new CPE's process method.

2.3.1. Using Listeners

Updates of the CPM's progress, including any errors that occur, are sent to the callback handler that is registered by the call to `addStatusCallbackListener`, above. The callback handler is a class that implements the CPM's `StatusCallbackListener` interface. It responds to events by printing messages to the console. The source code is fairly straightforward and is not included in this chapter – see the `org.apache.uima.examples.cpe.SimpleRunCPE.java` in the `%UIMA_HOME%\examples\src` directory for the complete code.

If you need more control over the information in the CPE descriptor, you can manually configure it via its API. See the Javadocs for package `org.apache.uima.collection` for more details.

2.4. Developing Collection Processing Components

This section is an introduction to the process of developing Collection Readers, CAS Initializers, and CAS Consumers. The code snippets refer to the classes that can be found in `%UIMA_HOME%\examples\src` example project.

In the following sections, classes you write to represent components need to be public and have public, 0-argument constructors, so that they can be instantiated by the framework. (Although Java classes in which you do not define any constructor will, by default, have a 0-argument constructor that doesn't do anything, a class in which you have defined at least one constructor does not get a default 0-argument constructor.)

2.4.1. Developing Collection Readers

A Collection Reader is responsible for obtaining documents from the collection and returning each document as a CAS. Like all UIMA components, a Collection Reader consists of two parts — the code and an XML descriptor.

A simple example of a Collection Reader is the “File System Collection Reader,” which simply reads documents from files in a specified directory. The Java code is in the class `org.apache.uima.examples.cpe.FileSystemCollectionReader` and the XML descriptor is `%UIMA_HOME%/examples/src/main/descriptors/collection_reader/FileSystemCollectionReader.xml`.

2.4.1.1. Java Class for the Collection Reader

The Java class for a Collection Reader must implement the `org.apache.uima.collection.CollectionReader` interface. You may build your Collection Reader from scratch and implement this interface, or you may extend the convenience base class `org.apache.uima.collection.CollectionReader_ImplBase`.

The convenience base class provides default implementations for many of the methods defined in the `CollectionReader` interface, and provides abstract definitions for those methods that you are required to implement in your new Collection Reader. Note that if you extend this base class, you do not need to declare that your new Collection Reader implements the `CollectionReader` interface.

Tip: Eclipse tip – if you are using Eclipse, you can quickly create the boiler plate code and stubs for all of the required methods by clicking `File` → `New` → `Class` to bring up the “New Java Class” dialogue, specifying `org.apache.uima.collection.CollectionReader_ImplBase` as the Superclass, and checking “Inherited abstract methods” in the section “Which method stubs would you like to create?”, as in the screenshot below:



For the rest of this section we will assume that your new Collection Reader extends the `CollectionReader_ImplBase` class, and we will show examples from the `org.apache.uima.examples.cpe.FileSystemCollectionReader`. If you must inherit from a different superclass, you must ensure that your Collection Reader implements the `CollectionReader` interface – see the Javadocs for `CollectionReader` for more details.

2.4.1.2. Required Methods in the Collection Reader class

The following abstract methods must be implemented:

initialize()

The `initialize()` method is called by the framework when the Collection Reader is first created. `CollectionReader_ImplBase` actually provides a default implementation of this method (i.e., it is not abstract), so you are not strictly required to implement this method. However, a typical Collection Reader will implement this method to obtain parameter values and perform various initialization steps.

In this method, the Collection Reader class can access the values of its configuration parameters and perform other initialization logic. The example File System Collection Reader reads its configuration parameters and then builds a list of files in the specified input directory, as follows:

```
public void initialize() throws ResourceInitializationException {
    File directory = new File(
        (String)getConfigParameterValue(PARAM_INPUTDIR));
    mEncoding = (String)getConfigParameterValue(PARAM_ENCODING);
    mDocumentTextXmlTagName = (String)getConfigParameterValue(PARAM_XMLTAG);
    mLanguage = (String)getConfigParameterValue(PARAM_LANGUAGE);
    mCurrentIndex = 0;

    //get list of files (not subdirectories) in the specified directory
    mFiles = new ArrayList();
    File[] files = directory.listFiles();
    for (int i = 0; i < files.length; i++) {
        if (!files[i].isDirectory()) {
            mFiles.add(files[i]);
        }
    }
}
```

Note: This is the zero-argument version of the initialize method. There is also a method on the Collection Reader interface called `initialize(ResourceSpecifier, Map)` but it is not recommended that you override this method in your code. That method performs internal initialization steps and then calls the zero-argument `initialize()`.

hasNext()

The `hasNext()` method returns whether or not there are any documents remaining to be read from the collection. The File System Collection Reader's `hasNext()` method is very simple. It just checks if there are any more files left to be read:

```
public boolean hasNext() {
    return mCurrentIndex < mFiles.size();
}
```

getNext(CAS)

The `getNext()` method reads the next document from the collection and populates a CAS. In the simple case, this amounts to reading the file and calling the CAS's `setDocumentText` method. The example File System Collection Reader is slightly more complex. It first checks for a CAS Initializer. If the CPE includes a CAS Initializer, the CAS Initializer is used to read the document, and `initialize()` the CAS. If the CPE does not include a CAS Initializer, the File System Collection Reader reads the document and sets the document text in the CAS.

The File System Collection Reader also stores additional metadata about the document in the CAS. In particular, it sets the document's language in the special

built-in feature structure `uima.tcas.DocumentAnnotation` (see Section 4.3, “Built-in CAS Types” for details about this built-in type) and creates an instance of `org.apache.uima.examples.SourceDocumentInformation`, which stores information about the document's source location. This information may be useful to downstream components such as CAS Consumers. Note that the type system descriptor for this type can be found in `org.apache.uima.examples.SourceDocumentInformation.xml`, which is located in the `examples/src` directory.

The `getNext()` method for the File System Collection Reader looks like this:

```
public void getNext(CAS aCAS) throws IOException, CollectionException {
    JCas jcas;
    try {
        jcas = aCAS.getJCas();
    } catch (CASException e) {
        throw new CollectionException(e);
    }

    // open input stream to file
    File file = (File) mFiles.get(mCurrentIndex++);
    BufferedInputStream fis =
        new BufferedInputStream(new FileInputStream(file));
    try {
        byte[] contents = new byte[(int) file.length()];
        fis.read(contents);
        String text;
        if (mEncoding != null) {
            text = new String(contents, mEncoding);
        } else {
            text = new String(contents);
        }
        // put document in CAS
        jcas.setDocumentText(text);
    } finally {
        if (fis != null)
            fis.close();
    }

    // set language if it was explicitly specified
    //as a configuration parameter
    if (mLanguage != null) {
        ((DocumentAnnotation) jcas.getDocumentAnnotationFs()).
            setLanguage(mLanguage);
    }

    // Also store location of source document in CAS.
    // This information is critical if CAS Consumers will
    // need to know where the original document contents
    // are located.
    // For example, the Semantic Search CAS Indexer
    // writes this information into the search index that
    // it creates, which allows applications that use the
    // search index to locate the documents that satisfy
    //their semantic queries.
    SourceDocumentInformation srcDocInfo =
        new SourceDocumentInformation(jcas);
    srcDocInfo.setUri(
        file.getAbsolutePath().toURL().toString());
    srcDocInfo.setOffsetInSource(0);
    srcDocInfo.setDocumentSize((int) file.length());
    srcDocInfo.setLastSegment(
```

```
mCurrentIndex == mFiles.size();
srcDocInfo.addToIndexes();
}
```

The Collection Reader can create additional annotations in the CAS at this point, in the same way that annotators create annotations.

getProgress()

The Collection Reader is responsible for returning progress information; that is, how much of the collection has been read thus far and how much remains to be read. The framework defines progress very generally; the Collection Reader simply returns an array of `Progress` objects, where each object contains three fields — the amount already completed, the total amount (if known), and a unit (e.g. entities (documents), bytes, or files). The method returns an array so that the Collection Reader can report progress in multiple different units, if that information is available. The File System Collection Reader's `getProgress()` method looks like this:

```
public Progress[] getProgress() {
    return new Progress[]{
        new ProgressImpl(mCurrentIndex, mFiles.size(), Progress.ENTITIES)};
}
```

In this particular example, the total number of files in the collection is known, but the total size of the collection is not known. As such, a `ProgressImpl` object for `Progress.ENTITIES` is returned, but a `ProgressImpl` object for `Progress.BYTES` is not.

close()

The close method is called when the Collection Reader is no longer needed. The Collection Reader should then release any resources it may be holding. The `FileSystemCollectionReader` does not hold resources and so has an empty implementation of this method:

```
public void close() throws IOException { }
```

Optional Methods

The following methods may be implemented:

reconfigure()

This method is called if the Collection Reader's configuration parameters change.

typeSystemInit()

If you are only setting the document text in the CAS, or if you are using the JCas (recommended, as in the current example, you do not have to implement this method. If you are directly using the CAS API, this method is used in the same way as it is used for an annotator – see Section 1.5.1, “Annotator Methods” for more information.

Threading considerations

Collection readers do not have to be thread safe; they are run with a single thread per instance, and only one instance per instance of the Collection Processing Manager (CPM) is made.

XML Descriptor for a Collection Reader

You can use the Component Description Editor to create and / or edit the File System Collection Reader's descriptor. Here is its descriptor (abbreviated somewhat), which is very similar to an Analysis Engine descriptor:

```
<collectionReaderDescription
  xmlns="http://uima.apache.org/resourceSpecifier">
  <frameworkImplementation>org.apache.uima.java</frameworkImplementation>
  <implementationName>
    org.apache.uima.examples.cpe.FileSystemCollectionReader
  </implementationName>
  <processingResourceMetaData>
    <name>File System Collection Reader</name>
    <description>Reads files from the filesystem.</description>
    <version>1.0</version>
    <vendor>The Apache Software Foundation</vendor>
    <configurationParameters>
      <configurationParameter>
        <name>InputDirectory</name>
        <description>Directory containing input files</description>
        <type>String</type>
        <multiValued>>false</multiValued>
        <mandatory>>true</mandatory>
      </configurationParameter>
      <configurationParameter>
        <name>Encoding</name>
        <description>Character encoding for the documents.</description>
        <type>String</type>
        <multiValued>>false</multiValued>
        <mandatory>>false</mandatory>
      </configurationParameter>
      <configurationParameter>
        <name>Language</name>
        <description>ISO language code for the documents</description>
        <type>String</type>
        <multiValued>>false</multiValued>
        <mandatory>>false</mandatory>
      </configurationParameter>
    </configurationParameters>
    <configurationParameterSettings>
      <nameValuePair>
        <name>InputDirectory</name>
        <value>
          <string>C:/Program Files/apache/uima/examples/data</string>
        </value>
      </nameValuePair>
    </configurationParameterSettings>

    <!-- Type System of CASEs returned by this Collection Reader -->

    <typeSystemDescription>
      <imports>
        <import name="org.apache.uima.examples.SourceDocumentInformation" />
      </imports>
    </typeSystemDescription>

    <capabilities>
      <capability>
        <inputs/>
        <outputs>
          <type allAnnotatorFeatures="true">
            org.apache.uima.examples.SourceDocumentInformation
          </type>
        </outputs>
      </capability>
    </capabilities>
  </processingResourceMetaData>
</collectionReaderDescription>
```

```
</capability>
</capabilities>
<operationalProperties>
  <modifiesCas>true</modifiesCas>
  <multipleDeploymentAllowed>false</multipleDeploymentAllowed>
  <outputsNewCASes>true</outputsNewCASes>
</operationalProperties>
</processingResourceMetaData>
</collectionReaderDescription>
```

2.4.2. Developing CAS Initializers

Note: CAS Initializers are now deprecated (as of version 2.1). For complex initialization, please use instead the capabilities of creating additional Subjects of Analysis (see Chapter 6, *Multiple CAS Views of an Artifact*).

In UIMA 1.x, the CAS Initializer component was intended to be used as a plug-in to the Collection Reader for when the task of populating the CAS from a raw document is complex and might be reusable with other data collections.

A CAS Initializer Java class must implement the interface `org.apache.uima.collection.CasInitializer`, and will also generally extend from the convenience base class `org.apache.uima.collection.CasInitializer_ImplBase`. A CAS Initializer also must have an XML descriptor, which has the exact same form as a Collection Reader Descriptor except that the outer tag is `<casInitializerDescription>`.

CAS Initializers have optional `initialize()`, `reconfigure()`, and `typeSystemInit()` methods, which perform the same functions as they do for Collection Readers. The only required method for a CAS Initializer is `initializeCas(Object, CAS)`. This method takes the raw document (for example, an `InputStream` object from which the document can be read) and a CAS, and populates the CAS from the document.

2.4.3. Developing CAS Consumers

Note: In version 2, there is no difference in capability between CAS Consumers and ordinary Analysis Engines, except for the default setting of the XML parameters for `multipleDeploymentAllowed` and `modifiesCas`. We recommend for future work that users implement and use Analysis Engine components instead of CAS Consumers.

A CAS Consumer receives each CAS after it has been analyzed by the Analysis Engine. CAS Consumers typically do not update the CAS; they typically extract data from the CAS and persist selected information to aggregate data structures such as search engine indexes or databases.

A CAS Consumer Java class must implement the interface `org.apache.uima.collection.CasConsumer`, and will also generally extend from the convenience base class `org.apache.uima.collection.CasConsumer_ImplBase`. A CAS Consumer also must have an XML descriptor, which has the exact same form as a Collection Reader Descriptor except that the outer tag is `<casConsumerDescription>`.

CAS Consumers have optional `initialize()`, `reconfigure()`, and `typeSystemInit()` methods, which perform the same functions as they do for Collection Readers and CAS Initializers. The only required method for a CAS Consumer is `processCas(CAS)`, which is where the CAS Consumer does the bulk of its work (i.e., consume the CAS).

The `CasConsumer` interface (as well as the version 2 Analysis Engine interface) additionally defines batch and collection level processing methods. The CAS Consumer or Analysis Engine can

implement the `batchProcessComplete()` method to perform processing that should occur at the end of each batch of CASes. Similarly, the CAS Consumer or Analysis Engine can implement the `collectionProcessComplete()` method to perform any collection level processing at the end of the collection.

A very simple example of a CAS Consumer, which writes an XML representation of the CAS to a file, is the XMI Writer CAS Consumer. The Java code is in the class `org.apache.uima.examples.cpe.XmiWriterCasConsumer` and the descriptor is in `%UIMA_HOME%/examples/descriptors/cas_consumer/XmiWriterCasConsumer.xml`.

2.4.3.1. Required Methods for a CAS Consumer

When extending the convenience class `org.apache.uima.collection.CasConsumer_ImplBase`, the following abstract methods must be implemented:

initialize()

The `initialize()` method is called by the framework when the CAS Consumer is first created. `CasConsumer_ImplBase` actually provides a default implementation of this method (i.e., it is not abstract), so you are not strictly required to implement this method. However, a typical CAS Consumer will implement this method to obtain parameter values and perform various initialization steps.

In this method, the CAS Consumer can access the values of its configuration parameters and perform other initialization logic. The example XMI Writer CAS Consumer reads its configuration parameters and sets up the output directory:

```
public void initialize() throws ResourceInitializationException {
    mDocNum = 0;
    mOutputDir = new File((String) getConfigParameterValue(PARAM_OUTPUTDIR));
    if (!mOutputDir.exists()) {
        mOutputDir.mkdirs();
    }
}
```

processCas()

The `processCas()` method is where the CAS Consumer does most of its work. In our example, the XMI Writer CAS Consumer obtains an iterator over the document metadata in the CAS (in the `SourceDocumentInformation` feature structure, which is created by the `File System Collection Reader`) and extracts the URI for the current document. From this the output filename is constructed in the output directory and a subroutine (`writeXmi`) is called to generate the output file. The `writeXmi` subroutine uses the `XmiCasSerializer` class provided with the UIMA SDK to serialize the CAS to the output file (see the example source code for details).

```
public void processCas(CAS aCAS) throws ResourceProcessException {
    String modelFileName = null;

    JCas jcas;
    try {
        jcas = aCAS.getJCas();
    } catch (CASEException e) {
        throw new ResourceProcessException(e);
    }

    // retrieve the filename of the input file from the CAS
```

```

FSIterator it = jcas
    .getAnnotationIndex(SourceDocumentInformation.type)
    .iterator();
File outFile = null;
if (it.hasNext()) {
    SourceDocumentInformation fileLoc =
        (SourceDocumentInformation) it.next();
    File inFile;
    try {
        inFile = new File(new URL(fileLoc.getUri()).getPath());
        String outFileName = inFile.getName();
        if (fileLoc.getOffsetInSource() > 0) {
            outFileName += ("_" + fileLoc.getOffsetInSource());
        }
        outFileName += ".xmi";
        outFile = new File(mOutputDir, outFileName);
        modelFileName = mOutputDir.getAbsolutePath() +
            "/" + inFile.getName() + ".ecore";
    } catch (MalformedURLException e1) {
        // invalid URL, use default processing below
    }
}
if (outFile == null) {
    outFile = new File(mOutputDir, "doc" + mDocNum++);
}
// serialize XCAS and write to output file
try {
    writeXmi(jcas.getCas(), outFile, modelFileName);
} catch (IOException e) {
    throw new ResourceProcessException(e);
} catch (SAXException e) {
    throw new ResourceProcessException(e);
}
}

```

Optional Methods

The following methods are optional in a CAS Consumer, though they are often used.

batchProcessComplete()

The framework calls the `batchProcessComplete()` method at the end of each batch of CASes. This gives the CAS Consumer or Analysis Engine an opportunity to perform any batch level processing. Our simple XMI Writer CAS Consumer does not perform any batch level processing, so this method is empty. Batch size is set in the Collection Processing Engine descriptor.

collectionProcessComplete()

The framework calls the `collectionProcessComplete()` method at the end of the collection (i.e., when all objects in the collection have been processed). At this point in time, no CAS is passed in as a parameter. This gives the CAS Consumer or Analysis Engine an opportunity to perform collection processing over the entire set of objects in the collection. Our simple XMI Writer CAS Consumer does not perform any collection level processing, so this method is empty.

2.5. Deploying a CPE

The CPM provides a number of service and deployment options that cover instantiation and execution of CPEs, error recovery, and local and distributed deployment of the CPE components.

The behavior of the CPM (and correspondingly, the CPE) is controlled by various options and parameters set in the CPE descriptor. The current version of the CPE Configurator tool, however, supports only default error handling and deployment options. To change these options, you must manually edit the CPE descriptor.

Eventually the CPE Configurator tool will support configuring these options and a detailed tutorial for these settings will be provided. In the meantime, we provide only a high-level, conceptual overview of these advanced features in the rest of this chapter, and refer the advanced user to Chapter 3, *Collection Processing Engine Descriptor Reference* for details on setting these options in the CPE Descriptor.

Figure 2.2, “CPE Instantiation” [61] shows a logical view of how an application uses the UIMA framework to instantiate a CPE from a CPE descriptor. The CPE descriptor identifies the CPE components (referencing their corresponding descriptors) and specifies the various options for configuring the CPM and deploying the CPE components.

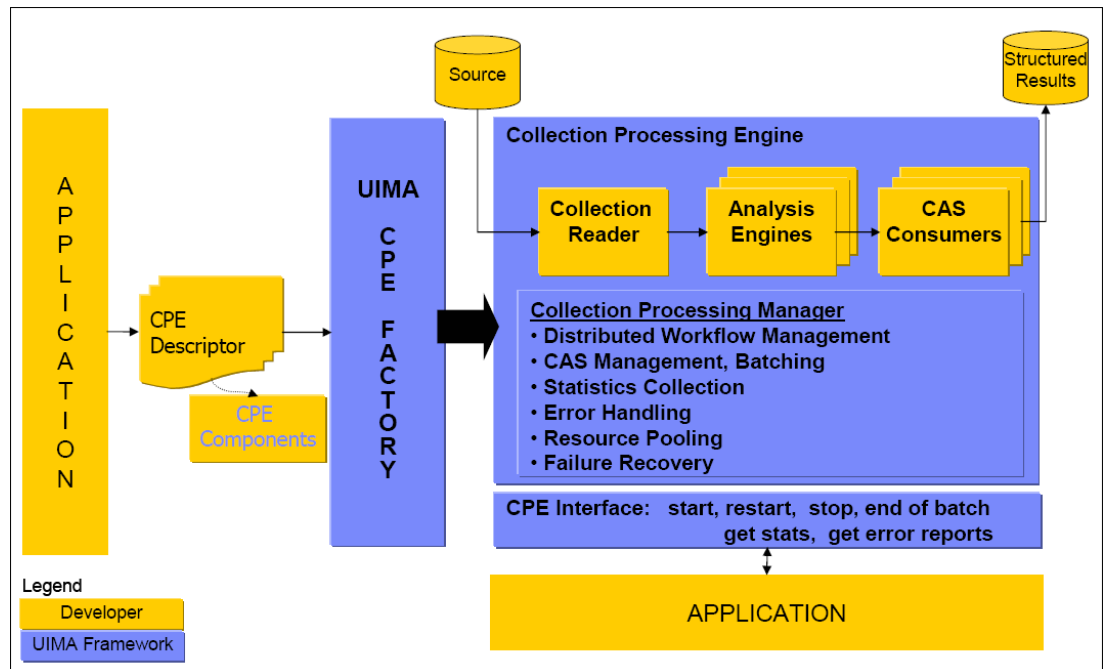

Figure 2.2. CPE Instantiation

There are three deployment modes for CAS Processors (Analysis Engines and CAS Consumers) in a CPE:

1. **Integrated** (runs in the same Java instance as the CPM)
2. **Managed** (runs in a separate process on the same machine), and
3. **Non-managed** (runs in a separate process, perhaps on a different machine).

An integrated CAS Processor runs in the same JVM as the CPE. A managed CAS Processor runs in a separate process from the CPE, but still on the same computer. The CPE controls startup, shutdown, and recovery of a managed CAS Processor. A non-managed CAS Processor runs as a service and may be on the same computer as the CPE or on a remote computer. A non-managed CAS Processor *service* is started and managed independently from the CPE.

For both managed and non-managed CAS Processors, the CAS must be transmitted between separate processes and possibly between separate computers. This is accomplished using *Vinci*, a communication protocol used by the CPM and which is provided as a part of Apache UIMA. Vinci handles service naming and location and data transport (see Section 3.6.2, “Deploying as a Vinci Service” for more information). Service naming and location are provided by a *Vinci Naming Service*, or *VNS*. For managed CAS Processors, the CPE uses its own internal VNS. For non-managed CAS Processors, a separate VNS must be running.

Note: The UIMA SDK also supports using unmanaged remote services via the web-standard SOAP communications protocol (see Section 3.6.1, “Deploying as SOAP Service”). This approach is based on a proxy implementation, where the proxy is essentially running in an integrated mode. To use this approach with the CPM, use the Integrated mode, with the component being an Aggregate which, in turn, connects to a remote service.

The CPE Configurator tool currently only supports constructing CPEs that deploy CAS Processors in integrated mode. To deploy CAS Processors in any other mode, the CPE descriptor must be edited by hand (better tooling may be provided later). Details on the CPE descriptor and the required settings for various CAS Processor deployment modes can be found in Chapter 3, *Collection Processing Engine Descriptor Reference*. In the following sections we merely summarize the various CAS Processor deployment options.

2.5.1. Deploying Managed CAS Processors

Managed CAS Processor deployment is shown in [Figure 2.3, “CPE with Managed CAS Processors”](#) [62]. A managed CAS Processor is deployed by the CPE as a Vinci service. The CPE manages the lifecycle of the CAS Processor including service launch, restart on failures, and service shutdown. A managed CAS Processor runs on the same machine as the CPE, but in a separate process. This provides the necessary fault isolation for the CPE to protect it from non-robust CAS Processors. A fatal failure of a managed CAS Processor does not threaten the stability of the CPE.

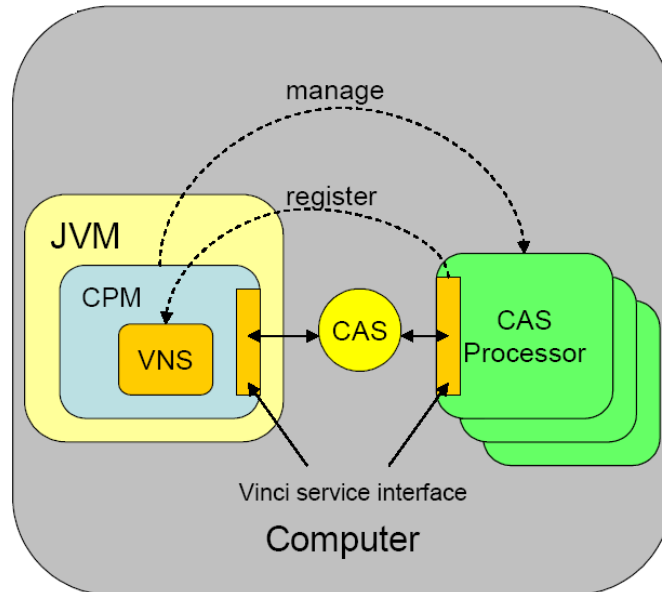

Figure 2.3. CPE with Managed CAS Processors

The CPE communicates with managed CAS Processors using the Vinci communication protocol. A CAS Processor is launched as a Vinci service and its `process()` method is invoked remotely via a Vinci command. The CPE uses its own internal VNS to support managed CAS processors. The VNS, by default, listens on port 9005. If this port is not available, the VNS will increment its listen port until it finds one that is available. All managed CAS Processors are internally configured to “talk” to the CPE managed VNS. This internal VNS is transparent to the end user launching the CPE.

To deploy a managed CAS Processor, the CPE deployer must change the CPE descriptor. The following is a section from the CPE descriptor that shows an example configuration specifying a managed CAS Processor.

```
<casProcessor deployment="local" name="Meeting Detector TAE">
  <descriptor>
    <include href="deploy/vinci/Deploy_MeetingDetectorTAE.xml"/>
  </descriptor>
  <runInSeparateProcess>
    <exec dir="." executable="java">
      <env key="CLASSPATH"
        value="src;
          C:/Program Files/apache/uima/lib/uima-core.jar;
          C:/Program Files/apache/uima/lib/uima-cpe.jar;
          C:/Program Files/apache/uima/lib/uima-examples.jar;
          C:/Program Files/apache/uima/lib/uima-adapter-vinci.jar;
          C:/Program Files/apache/uima/lib/jVinci.jar"/>
      <arg>-DLOG=C:/Temp/service.log</arg>
      <arg>org.apache.uima.reference_impl.collection.
        service.vinci.VinciAnalysisEngineService_impl</arg>
      <arg>${descriptor}</arg>
    </exec>
  </runInSeparateProcess>
  <deploymentParameters/>
  <filter/>
  <errorHandling>
    <errorRateThreshold action="terminate" value="1/100"/>
    <maxConsecutiveRestarts action="terminate" value="3"/>
    <timeout max="100000"/>
  </errorHandling>
  <checkpoint batch="10000"/>
</casProcessor>
```

See Chapter 3, *Collection Processing Engine Descriptor Reference* for details and required settings.

2.5.2. Deploying Non-managed CAS Processors

Non-managed CAS Processor deployment is shown in [Figure 2.4, “CPE with non-managed CAS Processors”](#) [64]. In non-managed mode, the CPE supports connectivity to CAS Processors running on local or remote computers using Vinci. Non-managed processors are different from managed processors in two aspects:

1. Non-managed processors are neither started nor stopped by the CPE.
2. Non-managed processors use an independent VNS, also neither started nor stopped by the CPE.

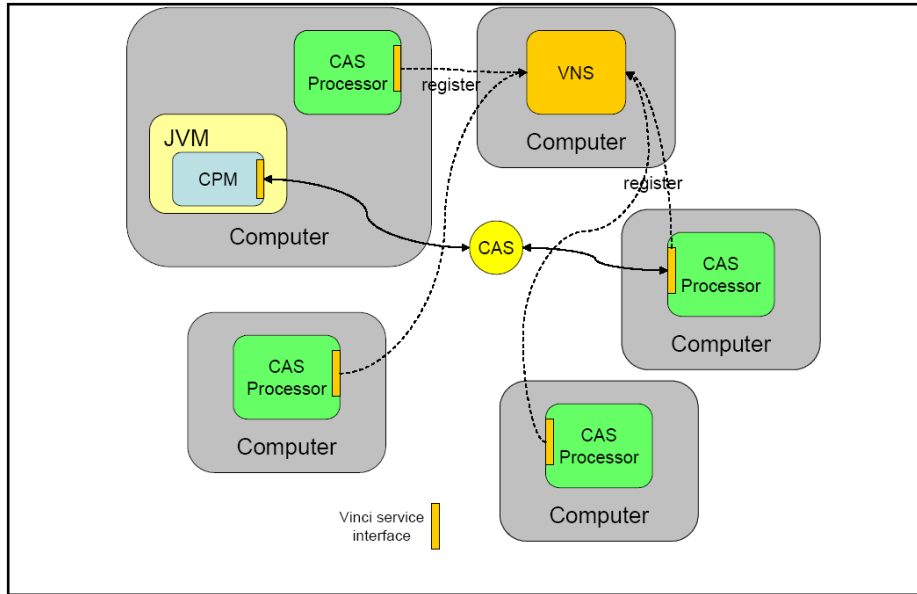

Figure 2.4. CPE with non-managed CAS Processors

While non-managed CAS Processors provide the same level of fault isolation and robustness as managed CAS Processors, error recovery support for non-managed CAS Processors is much more limited. In particular, the CPE cannot restart a non-managed CAS Processor after an error.

Non-managed CAS Processors also require a separate Vinci Naming Service running on the network. This VNS must be manually started and monitored by the end user or application. Instructions for running a VNS can be found in Section 3.6.5.1, “Starting VNS”.

To deploy a non-managed CAS Processor, the CPE deployer must change the CPE descriptor. The following is a section from the CPE descriptor that shows an example configuration for the non-managed CAS Processor.

```
<casProcessor deployment="remote" name="Meeting Detector TAE">
  <descriptor>
    <include href=
      "descriptors/vinciService/MeetingDetectorVinciService.xml" />
  </descriptor>
  <deploymentParameters/>
  <filter/>
  <errorHandling>
    <errorRateThreshold action="terminate" value="1/100"/>
    <maxConsecutiveRestarts action="terminate" value="3"/>
    <timeout max="100000"/>
  </errorHandling>
  <checkpoint batch="10000"/>
</casProcessor>
```

See Chapter 3, *Collection Processing Engine Descriptor Reference* for details and required settings.

2.5.3. Deploying Integrated CAS Processors

Integrated CAS Processors are shown in [Figure 2.5, “CPE with integrated CAS Processor”](#) [65]. Here the CAS Processors run in the same JVM as the CPE, just like the Collection Reader and CAS Initializer. This deployment method results in minimal CAS communication and transport overhead as the CAS is shared in the same process space of the

JVM. However, a CPE running with all integrated CAS Processors is limited in scalability by the capability of the single computer on which the CPE is running. There is also a stability risk associated with integrated processors because a poorly written CAS Processor can cause the JVM, and hence the entire CPE, to abort.

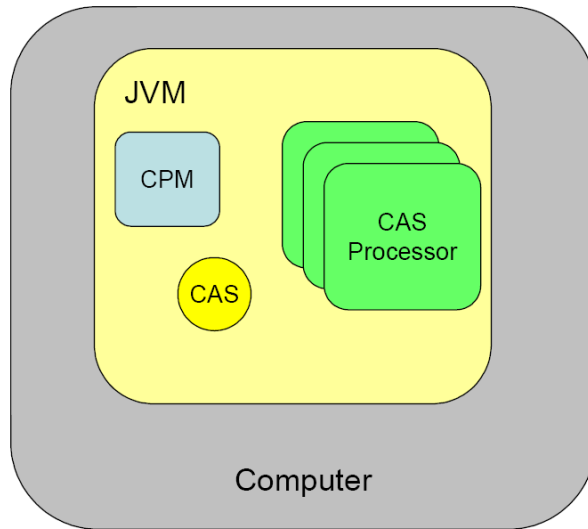

Figure 2.5. CPE with integrated CAS Processor

The following is a section from a CPE descriptor that shows an example configuration for the integrated CAS Processor.

```
<casProcessor deployment="integrated" name="Meeting Detector TAE">
  <descriptor>
    <include href="descriptors/tutorial/ex4/MeetingDetectorTAE.xml" />
  </descriptor>
  <deploymentParameters/>
  <filter/>
  <errorHandling>
    <errorRateThreshold action="terminate" value="100/1000"/>
    <maxConsecutiveRestarts action="terminate" value="30"/>
    <timeout max="100000"/>
  </errorHandling>
  <checkpoint batch="10000"/>
</casProcessor>
```

See Chapter 3, *Collection Processing Engine Descriptor Reference* for details and required settings.

2.6. Collection Processing Examples

The UIMA SDK includes a set of examples illustrating the three modes of deployment, integrated, managed, and non-managed. These are in the `/examples/descriptors/collection_processing_engine` directory. There are three CPE descriptors that run an example annotator (the Meeting Finder) in these modes.

To run either the integrated or managed examples, use the `runCPE` script in the `/bin` directory of the UIMA installation, passing the appropriate CPE descriptor as an argument, or if you're using Eclipse and have the `uima-j-examples` project in your workspace, you can use the Eclipse Menu `→ Run → Run... →` and then pick the launch configuration "UIMA Run CPE".

Note: The `runCPE` script *must* be run from the `%UIMA_HOME%\examples` directory, because the example CPE descriptors use relative path names that are resolved relative to this working directory. For instance,

```
runCPE
descriptors\collection_processing_engine\MeetingFinderCPE_Integrated.xml
```

To run the non-managed example, there are some additional steps.

1. Start a VNS service by running the `startVNS` script in the `/bin` directory, or using the Eclipse launcher “UIMA Start VNS”.
2. Deploy the Meeting Detector Analysis Engine as a Vinci service, by running the `startVinciService` script in the `/bin` directory or using the Eclipse launcher for this, and passing it the location of the descriptor to deploy, in this case `%UIMA_HOME%/examples/deploy/vinci/Deploy_MeetingDetectorTAE.xml`, or if you're using Eclipse and have the `uimaj-examples` project in your workspace, you can use the Eclipse Menu → Run → Run... → and then pick the launch configuration “UIMA Start Vinci Service”.
3. Now, run the `runCPE` script (or if in Eclipse, run the launch configuration “UIMA Run CPE”), passing it the CPE for the non-managed version (`%UIMA_HOME%/examples/descriptors/collection_processing_engine/MeetingFinderCPE_NonManaged.xml`).

This assumes that the Vinci Naming Service, the `runCPE` application, and the `MeetingDetectorTAE` service are all running on the same machine. Most of the scripts that need information about VNS will look for values to use in environment variables `VNS_HOST` and `VNS_PORT`; these default to “localhost” and “9000”. You may set these to appropriate values before running the scripts, as needed; you can also pass the name of the VNS host as the second argument to the `startVinciService` script.

Alternatively, you can edit the scripts and/or the XML files to specify alternatives for the `VNS_HOST` and `VNS_PORT`. For instance, if the `runCPE` application is running on a different machine from the Vinci Naming Service, you can edit the `MeetingFinderCPE_NonManaged.xml` and change the `vnsHost` parameter: `<parameter name="vnsHost" value="localhost" type="string"/>` to specify the VNS host instead of “localhost”.

Chapter 3. Application Developer's Guide

This chapter describes how to develop an application using the Unstructured Information Management Architecture (UIMA). The term *application* describes a program that provides end-user functionality. A UIMA application incorporates one or more UIMA components such as Analysis Engines, Collection Processing Engines, a Search Engine, and/or a Document Store and adds application-specific logic and user interfaces.

3.1. The UIMAFramework Class

An application developer's starting point for accessing UIMA framework functionality is the `org.apache.uima.UIMAFramework` class. The following is a short introduction to some important methods on this class. Several of these methods are used in examples in the rest of this chapter. For more details, see the Javadocs (in the docs/api directory of the UIMA SDK).

- `UIMAFramework.getXMLParser()`: Returns an instance of the UIMA XML Parser class, which then can be used to parse the various types of UIMA component descriptors. Examples of this can be found in the remainder of this chapter.
- `UIMAFramework.produceXXX(ResourceSpecifier)`: There are various produce methods that are used to create different types of UIMA components from their descriptors. The argument type, `ResourceSpecifier`, is the base interface that subsumes all types of component descriptors in UIMA. You can get a `ResourceSpecifier` from the `XMLParser`. Examples of produce methods are:
 - `produceAnalysisEngine`
 - `produceCasConsumer`
 - `produceCasInitializer`
 - `produceCollectionProcessingEngine`
 - `produceCollectionReader`

There are other variations of each of these methods that take additional, optional arguments. See the Javadocs for details.

- `UIMAFramework.getLogger(<optional-logger-name>)`: Gets a reference to the UIMA Logger, to which you can write log messages. If no logger name is passed, the name of the returned logger instance is “org.apache.uima”.
- `UIMAFramework.getVersionString()`: Gets the number of the UIMA version you are using.
- `UIMAFramework.newDefaultResourceManager()`: Gets an instance of the UIMA `ResourceManager`. The key method on `ResourceManager` is `setDataPath`, which allows you to specify the location where UIMA components will go to look for their external resource files. Once you've obtained and initialized a `ResourceManager`, you can pass it to any of the `produceXXX` methods.

3.2. Using Analysis Engines

This section describes how to add analysis capability to your application by using Analysis Engines developed using the UIMA SDK. An *Analysis Engine (AE)* is a component that analyzes artifacts (e.g. documents) and infers information about them.

An Analysis Engine consists of two parts - Java classes (typically packaged as one or more JAR files) and *AE descriptors* (one or more XML files). You must put the Java classes in your application's class path, but thereafter you will not need to directly interact with them. The UIMA framework insulates you from this by providing a standard AnalysisEngine interfaces.

The term *Text Analysis Engine (TAE)* is sometimes used to describe an Analysis Engine that analyzes a text document. In the UIMA SDK v1.x, there was a TextAnalysisEngine interface that was commonly used. However, as of the UIMA SDK v2.0, this interface has been deprecated and all applications should switch to using the standard AnalysisEngine interface.

The AE descriptor XML files contain the configuration settings for the Analysis Engine as well as a description of the AE's input and output requirements. You may need to edit these files in order to configure the AE appropriately for your application - the supplier of the AE may have provided documentation (or comments in the XML descriptor itself) about how to do this.

3.2.1. Instantiating an Analysis Engine

The following code shows how to instantiate an AE from its XML descriptor:

```
//get Resource Specifier from XML file
XMLInputSource in = new XMLInputSource("MyDescriptor.xml");
ResourceSpecifier specifier =
    UIMAFramework.getXMLParser().parseResourceSpecifier(in);

//create AE here
AnalysisEngine ae =
    UIMAFramework.produceAnalysisEngine(specifier);
```

The first two lines parse the XML descriptor (for AEs with multiple descriptor files, one of them is the “main” descriptor - the AE documentation should indicate which it is). The result of the parse is a ResourceSpecifier object. The third line of code invokes a static factory method UIMAFramework.produceAnalysisEngine, which takes the specifier and instantiates an AnalysisEngine object.

There is one caveat to using this approach - the Analysis Engine instance that you create will not support multiple threads running through it concurrently. If you need to support this, see [Section 3.2.5, “Multi-threaded Applications” \[70\]](#).

3.2.2. Analyzing Text Documents

There are two ways to use the AE interface to analyze documents. You can either use the *JCas* interface, which is described in detail by Chapter 5, *JCas Reference* or you can directly use the *CAS* interface, which is described in detail in Chapter 4, *CAS Reference*. Besides text documents, other kinds of artifacts can also be analyzed; see Chapter 5, *Annotations, Artifacts, and Sofas* for more information.

The basic structure of your application will look similar in both cases:

Using the JCas

```
//create a JCas, given an Analysis Engine (ae)
JCas jcas = ae.newJCas();

//analyze a document
jcas.setDocumentText(doc1text);
```

```
ae.process(jcas);
doSomethingWithResults(jcas);
jcas.reset();

    //analyze another document
jcas.setDocumentText(doc2text);
ae.process(jcas);
doSomethingWithResults(jcas);
jcas.reset();
...
//done
ae.destroy();
```

Using the CAS

```
//create a CAS
CAS aCasView = ae.newCAS();

//analyze a document
aCasView.setDocumentText(doc1text);
ae.process(aCasView);
doSomethingWithResults(aCasView);
aCasView.reset();

//analyze another document
aCasView.setDocumentText(doc2text);
ae.process(aCasView);
doSomethingWithResults(aCasView);
aCasView.reset();
...
//done
ae.destroy();
```

First, you create the CAS or JCas that you will use. Then, you repeat the following four steps for each document:

1. Put the document text into the CAS or JCas.
2. Call the AE's process method, passing the CAS or JCas as an argument
3. Do something with the results that the AE has added to the CAS or JCas
4. Call the CAS's or JCas's reset() method to prepare for another analysis

3.2.3. Analyzing Non-Text Artifacts

Analyzing non-text artifacts is similar to analyzing text documents. The main difference is that instead of using the `setDocumentText` method, you need to use the Sofa APIs to set the artifact into the CAS. See Chapter 5, *Annotations, Artifacts, and Sofas* for details.

3.2.4. Accessing Analysis Results

Annotators (and applications) access the results of analysis via the CAS, using the CAS or JCas interfaces. These results are accessed using the CAS Indexes. There is one built-in index for instances of the built-in type `uima.tcas.Annotation` that can be used to retrieve instances of `Annotation` or any subtype of `Annotation`. You can also define additional indexes over other types.

Indexes provide a method to obtain an iterators over their contents; the iterator returns the matching elements one at a time from the CAS.

3.2.4.1. Accessing Analysis Results using the JCas

See:

- Section 1.3.3, “Reading the Results of Previous Annotators”
- Chapter 5, *JCas Reference*
- The Javadocs for `org.apache.uima.jcas.JCas`.

3.2.4.2. Accessing Analysis Results using the CAS

See:

- Chapter 4, *CAS Reference*
- The source code for `org.apache.uima.examples.PrintAnnotations`, which is in `examples\src`.
- The Javadocs for the `org.apache.uima.cas` and `org.apache.uima.cas.text` packages.

3.2.5. Multi-threaded Applications

The simplest way to use an AE in a multi-threaded environment is to use the Java synchronized keyword to ensure that only one thread is using an AE at any given time. For example:

```
public class MyApplication {
    private AnalysisEngine mAnalysisEngine;
    private CAS mCAS;

    public MyApplication() {
        //get Resource Specifier from XML file
        XMLInputSource in = new XMLInputSource("MyDescriptor.xml");
        ResourceSpecifier specifier =
            UIMAFramework.getXMLParser().parseResourceSpecifier(in);

        //create Analysis Engine here
        mAnalysisEngine = UIMAFramework.produceAnalysisEngine(specifier);
        mCAS = mAnalysisEngine.newCAS();
    }

    // Assume some other part of your multi-threaded application could
    // call "analyzeDocument" on different threads, asynchronously

    public synchronized void analyzeDocument(String aDoc) {
        //analyze a document
        mCAS.setDocumentText(aDoc);
        mAnalysisEngine.process();
        doSomethingWithResults(mCAS);
        mCAS.reset();
    }
    ...
}
```

Without the synchronized keyword, this application would not be thread-safe. If multiple threads called the `analyzeDocument` method simultaneously, they would both use the same CAS and

clobber each others' results. The synchronized keyword ensures that no more than one thread is executing this method at any given time. For more information on thread synchronization in Java, see <http://java.sun.com/docs/books/tutorial/essential/threads/multithreaded.html>.

The synchronized keyword ensures thread-safety, but does not allow you to process more than one document at a time. If you need to process multiple documents simultaneously (for example, to make use of a multiprocessor machine), you'll need to use more than one CAS instance.

Because CAS instances use memory and can take some time to construct, you don't want to create a new CAS instance for each request. Instead, you should use a feature of the UIMA SDK called the *CAS Pool*, implemented by the type `CasPool`.

A CAS Pool contains some number of CAS instances (you specify how many when you create the pool). When a thread wants to use a CAS, it *checks out* an instance from the pool. When the thread is done using the CAS, it must *release* the CAS instance back into the pool. If all instances are checked out, additional threads will block and wait for an instance to become available. Here is some example code:

```
public class MyApplication {
    private CasPool mCasPool;

    private AnalysisEngine mAnalysisEngine;

    public MyApplication()
    {
        //get Resource Specifier from XML file
        XMLInputSource in = new XMLInputSource("MyDescriptor.xml");
        ResourceSpecifier specifier =
            UIMAFramework.getXMLParser().parseResourceSpecifier(in);

        //Create multithreadable AE that will
        //Accept 3 simultaneous requests
        //The 3rd parameter specifies a timeout.
        //When the number of simultaneous requests exceeds 3,
        // additional requests will wait for other requests to finish.
        // This parameter determines the maximum number of milliseconds
        // that a new request should wait before throwing an
        // - a value of 0 will cause them to wait forever.
        mAnalysisEngine = UIMAFramework.produceAnalysisEngine(specifier,3,0);

        //create CAS pool with 3 CAS instances
        mCasPool = new CasPool(3, mAnalysisEngine);
    }

    public void analyzeDocument(String aDoc) {
        //check out a CAS instance (argument 0 means no timeout)
        CAS cas = mCasPool.getCas(0);
        try {
            //analyze a document
            cas.setDocumentText(aDoc);
            mAnalysisEngine.process(cas);
            doSomethingWithResults(cas);
        } finally {
            //MAKE SURE we release the CAS instance
            mCasPool.releaseCas(cas);
        }
    }
    ...
}
```

There is not much more code required here than in the previous example. First, there is one additional parameter to the `AnalysisEngine` producer, specifying the number of annotator instances to create¹. Then, instead of creating a single CAS in the constructor, we now create a `CasPool` containing 3 instances. In the `analyze` method, we check out a CAS, use it, and then release it.

Note: Frequently, the two numbers (number of CASes, and the number of AEs) will be the same. It would not make sense to have the number of CASes less than the number of AEs – the extra AE instances would always block waiting for a CAS from the pool. It could make sense to have additional CASes, though – if you had other multi-threaded processes that were using the CASes, other than the AEs.

The `getCAS()` method returns a CAS which is not specialized to any particular subject of analysis. To process things other than this, please refer to Chapter 5, *Annotations, Artifacts, and Sofas*.

Note the use of the `try...finally` block. This is very important, as it ensures that the CAS we have checked out will be released back into the pool, even if the analysis code throws an exception. You should always use `try...finally` when using the CAS pool; if you do not, you risk exhausting the pool and causing deadlock.

The parameter 0 passed to the `CasPool.getCas()` method is a timeout value. If this is set to a positive integer, it is the maximum number of milliseconds that the thread will wait for an instance to become available in the pool. If this time elapses, the `getCas` method will return null, and the application can do something intelligent, like ask the user to try again later. A value of 0 will cause the thread to wait for an available CAS, potentially forever.

3.2.6. Using Multiple Analysis Engines and Creating Shared CASes

In most cases, the easiest way to use multiple Analysis Engines from within an application is to combine them into an aggregate AE. For instructions, see Section 1.3, “Building Aggregate Analysis Engines”. Be sure that you understand this method before deciding to use the more advanced feature described in this section.

If you decide that your application does need to instantiate multiple AEs and have those AEs share a single CAS, then you will no longer be able to use the various methods on the `AnalysisEngine` class that create CASes (or JCases) to create your CAS. This is because these methods create a CAS with a data model specific to a single AE and which therefore cannot be shared by other AEs. Instead, you create a CAS as follows:

Suppose you have two analysis engines, and one CAS Consumer, and you want to create one type system from the merge of all of their type specifications. Then you can do the following:

```
AnalysisEngineDescription aeDesc1 =
    UIMAFramework.getXMLParser().parseAnalysisEngineDescription(...);

AnalysisEngineDescription aeDesc2 =
    UIMAFramework.getXMLParser().parseAnalysisEngineDescription(...);

CasConsumerDescription ccDesc =
    UIMAFramework.getXMLParser().parseCasConsumerDescription(...);

List list = new ArrayList();
```

¹ Both the UIMA Collection Processing Manager framework and the remote deployment services framework have implementations which use CAS pools in this manner, and thereby relieve the annotator developer of the necessity to make their annotators thread-safe.

```
list.add(aeDesc1);
list.add(aeDesc2);
list.add(ccDesc);

CAS cas = CasCreationUtils.createCas(list);

// (optional, if using the JCas interface)
JCas jcas = cas.getJCas();
```

The `CasCreationUtils` class takes care of the work of merging the AEs' type systems and producing a CAS for the combined type system. If the type systems are not compatible, an exception will be thrown.

3.2.7. Saving CASes to file systems

The UIMA framework provides APIs to save and restore the contents of a CAS to streams. The CASes are stored in an XML format. There are two forms of this format. The preferred form is the XMI form (see Section 8.3, “Using XMI CAS Serialization”). An older format is also available, called XCAS.

To save an XMI representation of a CAS, use the `serialize` method of the class `org.apache.uima.util.XmlCasSerializer`. To save an XCAS representation of a CAS, use the class `org.apache.uima.cas.impl.XCASSerializer` instead; see the Javadocs for details.

Both of these external forms can be read back in, using the `deserialize` method of the class `org.apache.uima.util.XmlCasDeserializer`. This method deserializes into a pre-existing CAS, which you must create ahead of time, pre-set-up with the proper type system. See the Javadocs for details.

3.3. Using Collection Processing Engines

A *Collection Processing Engine (CPE)* processes collections of artifacts (documents) through the combination of the following components: a Collection Reader, an optional CAS Initializer, Analysis Engines, and CAS Consumers. Collection Processing Engines and their components are described in Chapter 2, *Collection Processing Engine Developer's Guide*.

Like Analysis Engines, CPEs consist of a set of Java classes and a set of descriptors. You need to make sure the Java classes are in your classpath, but otherwise you only deal with descriptors.

3.3.1. Running a Collection Processing Engine from a Descriptor

Section 2.3, “Running a CPE from Your Own Java Application” describes how to use the APIs to read a CPE descriptor and run it from an application.

3.3.2. Configuring a Collection Processing Engine Descriptor Programmatically

For the finest level of control over the CPE descriptor settings, the CPE offers programmatic access to the descriptor via an API. With this API, a developer can create a complete descriptor and then save the result to a file. This also can be used to read in a descriptor (using `XMLParser.parseCpeDescription` as shown in the previous section), modify it, and write it back

out again. The CPE Descriptor API allows a developer to redefine default behavior related to error handling for each component, turn-on check-pointing, change performance characteristics of the CPE, and plug-in a custom timer.

Below is some example code that illustrates how this works. See the Javadocs for package `org.apache.uima.collection.metadata` for more details.

```
//Creates descriptor with default settings
CpeDescription cpe = CpeDescriptorFactory.produceDescriptor();

//Add CollectionReader
cpe.addCollectionReader([descriptor]);

//Add CasInitializer (deprecated)
cpe.addCasInitializer(<cas initializer descriptor>);

// Provide the number of CASes the CPE will use
cpe.setCasPoolSize(2);

// Define and add Analysis Engine
CpeIntegratedCasProcessor personTitleProcessor =
    CpeDescriptorFactory.produceCasProcessor ("Person");

// Provide descriptor for the Analysis Engine
personTitleProcessor.setDescriptor([descriptor]);

//Continue, despite errors and skip bad Cas
personTitleProcessor.setActionOnMaxError("continue");

//Increase amount of time in ms the CPE waits for response
//from this Analysis Engine
personTitleProcessor.setTimeout(100000);

//Add Analysis Engine to the descriptor
cpe.addCasProcessor(personTitleProcessor);

// Define and add CAS Consumer
CpeIntegratedCasProcessor consumerProcessor =
    CpeDescriptorFactory.produceCasProcessor("Printer");
consumerProcessor.setDescriptor([descriptor]);

//Define batch size
consumerProcessor.setBatchSize(100);

//Terminate CPE on max errors
consumerProcessor.setActionOnMaxError("terminate");

//Add CAS Consumer to the descriptor
cpe.addCasProcessor(consumerProcessor);

// Add Checkpoint file and define checkpoint frequency (ms)
cpe.setCheckpoint("[path]/checkpoint.dat", 3000);

// Plug in custom timer class used for timing events
cpe.setTimer("org.apache.uima.internal.util.JavaTimer");

// Define number of documents to process
cpe.setNumToProcess(1000);

// Dump the descriptor to the System.out
((CpeDescriptionImpl)cpe).toXML(System.out);
```

The CPE descriptor for the above configuration looks like this:

```
<?xml version="1.0" encoding="UTF-8"?>
<cpeDescription xmlns="http://uima.apache.org/resourceSpecifier">
  <collectionReader>
    <collectionIterator>
      <descriptor>
        <include href="[descriptor]"/>
      </descriptor>
      <configurationParameterSettings>...
    </configurationParameterSettings>
  </collectionIterator>

  <casInitializer>
    <descriptor>
      <include href="[descriptor]"/>
    </descriptor>
    <configurationParameterSettings>...
  </configurationParameterSettings>
</casInitializer>
</collectionReader>

<casProcessors casPoolSize="2" processingUnitThreadCount="1">
  <casProcessor deployment="integrated" name="Person">
    <descriptor>
      <include href="[descriptor]"/>
    </descriptor>
    <deploymentParameters/>
    <errorHandling>
      <errorRateThreshold action="terminate" value="100/1000"/>
      <maxConsecutiveRestarts action="terminate" value="30"/>
      <timeout max="100000"/>
    </errorHandling>
    <checkpoint batch="100" time="1000ms"/>
  </casProcessor>

  <casProcessor deployment="integrated" name="Printer">
    <descriptor>
      <include href="[descriptor]"/>
    </descriptor>
    <deploymentParameters/>
    <errorHandling>
      <errorRateThreshold action="terminate"
        value="100/1000"/>
      <maxConsecutiveRestarts action="terminate"
        value="30"/>
      <timeout max="100000" default="-1"/>
    </errorHandling>
    <checkpoint batch="100" time="1000ms"/>
  </casProcessor>
</casProcessors>

<cpeConfig>
  <numToProcess>1000</numToProcess>
  <deployAs>immediate</deployAs>
  <checkpoint file="[path]/checkpoint.dat" time="3000ms"/>
  <timerImpl>
    org.apache.uima.reference_impl.util.JavaTimer
  </timerImpl>
</cpeConfig>
</cpeDescription>
```

3.4. Setting Configuration Parameters

Configuration parameters can be set using APIs as well as configured using the XML descriptor metadata specification (see Section 1.2.1, “Configuration Parameters”).

There are two different places you can set the parameters via the APIs.

- After reading the XML descriptor for a component, but before you produce the component itself, and
- After the component has been produced.

Setting the parameters before you produce the component is done using the `ConfigurationParameterSettings` object. You get an instance of this for a particular component by accessing that component description's metadata. For instance, if you produced a component description by using `UIMAFramework.getXMLParser().parse...` method, you can use that component description's `getMetaData()` method to get the metadata, and then the metadata's `getConfigurationParameterSettings` method to get the `ConfigurationParameterSettings` object. Using that object, you can set individual parameters using the `setParameterValue` method. Here's an example, for a CAS Consumer component:

```
// Create a description object by reading the XML for the descriptor
CasConsumerDescription casConsumerDesc =
    UIMAFramework.getXMLParser().parseCasConsumerDescription(new
        XMLInputSource("descriptors/cas_consumer/InlineXmlCasConsumer.xml"));

// get the settings from the metadata
ConfigurationParameterSettings consumerParamSettings =
    casConsumerDesc.getMetaData().getConfigurationParameterSettings();

// Set a parameter value
consumerParamSettings.setParameterValue(
    InlineXmlCasConsumer.PARAM_OUTPUTDIR,
    outputDir.getAbsolutePath());
```

Then you might produce this component using:

```
CasConsumer component =
    UIMAFramework.produceCasConsumer(casConsumerDesc);
```

A side effect of producing a component is calling the component's “initialize” method, allowing it to read its configuration parameters. If you want to change parameters after this, use

```
component.setConfigParameterValue(
    "<parameter-name>",
    "<parameter-value>");
```

and then signal the component to re-read its configuration by calling the component's `reconfigure` method:

```
component.reconfigure();
```

Although these examples are for a CAS Consumer component, the parameter APIs also work for other kinds of components.

3.5. Integrating Text Analysis and Search

The UIMA SDK on IBM's alphaWorks <http://www.alphaworks.ibm.com/tech/uima> includes a semantic search engine that you can use to build a search index that includes the results of the analysis done by your AE. This combination of AEs with a search engine capable of indexing both words and annotations over spans of text enables what UIMA refers to as *semantic search*. Over time we expect to provide additional information on integrating other open source search engines.

Semantic search is a search where the semantic intent of the query is specified using one or more entity or relation specifiers. For example, one could specify that they are looking for a person (named) "Bush." Such a query would then not return results about the kind of bushes that grow in your garden.

3.5.1. Building an Index

To build a semantic search index using the UIMA SDK, you run a Collection Processing Engine that includes your AE along with a CAS Consumer which takes the tokens and annotations, together with sentence boundaries, and feeds them to a semantic searcher's index term input. The alphaWorks semantic search component includes a CAS Consumer called the *Semantic Search CAS Indexer* that does this; this component is available from the alphaWorks site. Your AE must include an annotator that produces Tokens and Sentence annotations, along with any "semantic" annotations, because the Indexer requires this. The Semantic Search CAS Indexer's descriptor is located here: `examples/descriptors/cas_consumer/SemanticSearchCasIndexer.xml`.

3.5.1.1. Configuring the Semantic Search CAS Indexer

Since there are several ways you might want to build a search index from the information in the CAS produced by your AE, you need to supply the Semantic Search CAS Consumer – Indexer with configuration information in the form of an *Index Build Specification* file. Apache UIMA includes code for parsing Index Build Specification files (see the Javadocs for details). An example of an Indexing specification tailored to the AE from the tutorial in the Chapter 1, *Annotator and Analysis Engine Developer's Guide* is located in `examples/descriptors/tutorial/search/MeetingIndexBuildSpec.xml`. It looks like this:

```
<indexBuildSpecification>
  <indexBuildItem>
    <name>org.apache.uima.examples.tokenizer.Token</name>
    <indexRule>
      <style name="Term"/>
    </indexRule>
  </indexBuildItem>
  <indexBuildItem>
    <name>org.apache.uima.examples.tokenizer.Sentence</name>
    <indexRule>
      <style name="Breaking"/>
    </indexRule>
  </indexBuildItem>
  <indexBuildItem>
    <name>org.apache.uima.tutorial.Meeting</name>
    <indexRule>
      <style name="Annotation"/>
    </indexRule>
  </indexBuildItem>
  <indexBuildItem>
    <name>org.apache.uima.tutorial.RoomNumber</name>
```

```

<indexRule>
  <style name="Annotation">
    <attributeMappings>
      <mapping>
        <feature>building</feature>
        <indexName>building</indexName>
      </mapping>
    </attributeMappings>
  </style>
</indexRule>
</indexBuildItem>
<indexBuildItem>
  <name>org.apache.uima.tutorial.DateAnnot</name>
  <indexRule>
    <style name="Annotation"/>
  </indexRule>
</indexBuildItem>
<indexBuildItem>
  <name>org.apache.uima.tutorial.TimeAnnot</name>
  <indexRule>
    <style name="Annotation"/>
  </indexRule>
</indexBuildItem>
</indexBuildSpecification>

```

The index build specification is a series of index build items, each of which identifies a CAS annotation type (a subtype of `uima.tcas.Annotation` – see Chapter 4, *CAS Reference*) and a style.

The first item in this example specifies that the annotation type `org.apache.uima.examples.tokenizer.Token` should be indexed with the “Term” style. This means that each span of text annotated by a `Token` will be considered a single token for standard text search purposes.

The second item in this example specifies that the annotation type `org.apache.uima.examples.tokenizer.Sentence` should be indexed with the “Breaking” style. This means that each span of text annotated by a `Sentence` will be considered a single sentence, which can affect that search engine’s algorithm for matching queries. The semantic search engine available from `alphaWorks` always requires tokens and sentences in order to index a document.

Note: Requirements for Term and Breaking rules: The Semantic Search indexer from `alphaWorks` requires that the items to be indexed as words be designated using the Term rule.

The remaining items all use the “Annotation” style. This indicates that each annotation of the specified types will be stored in the index as a searchable span, with a name equal to the annotation name (without the namespace).

Also, features of annotations can be indexed using the `<attributeMappings>` subelement. In the example index build specification, we declare that the `building` feature of the type `org.apache.uima.tutorial.RoomNumber` should be indexed. The `<indexName>` element can be used to map the feature name to a different name in the index, but in this example we have opted to use the same name, `building`.

At the end of the batch or collection, the Semantic Search CAS Indexer builds the index. This index can be queried with simple tokens or with XML tags.

Examples:

- A query on the word “UIMA” will retrieve all documents that have the occurrence of the word. But a query of the type `<Meeting>UIMA</Meeting>` will retrieve only those documents that contain a Meeting annotation (produced by our MeetingDetector TAE, for example), where that Meeting annotation contains the word “UIMA”.
- A query for `<RoomNumber building="Yorktown" />` will return documents that have a RoomNumber annotation whose `building` feature contains the term “Yorktown”.

More information on the syntax of these kinds of queries, called XML Fragments, can be found in documentation for the semantic search engine component on <http://www.alphaworks.ibm.com/tech/uima>. For more information on the Index Build Specification format, see the UIMA Javadocs for class `org.apache.uima.search.IndexBuildSpecification`. Accessing the Javadocs is described Chapter 1, *Javadocs*.

3.5.1.2. Building and Running a CPE including the Semantic Search CAS Indexer

The following steps illustrate how to build and run a CPE that uses the UIMA Meeting Detector TAE and the Simple Token and Sentence Annotator, discussed in the Chapter 1, *Annotator and Analysis Engine Developer's Guide* along with a CAS Consumer called the Semantic Search CAS Indexer, to build an index that allows you to query for documents based not only on textual content but also on whether they contain mentions of Meetings detected by the TAE.

Run the CPE Configurator tool by executing the `cpeGui` shell script in the `bin` directory of the UIMA SDK. (For instructions on using this tool, see the Chapter 2, *Collection Processing Engine Configurator User's Guide*.)

In the CPE Configurator tool, select the following components by browsing to their descriptors:

- Collection Reader: `%UIMA_HOME%/examples/descriptors/collectionReader/FileSystemCollectionReader.xml`
- Analysis Engine: include both of these; one produces tokens/sentences, required by the indexer in all cases and the other produces the meeting annotations of interest.
 - `%UIMA_HOME%/examples/descriptors/analysis_engine/SimpleTokenAndSentenceAnnotator.xml`
 - `%UIMA_HOME%/examples/descriptors/tutorial/ex6/UIMAMeetingDetectorTAE.xml`
- Two CAS Consumers:
 - `%UIMA_HOME%/examples/descriptors/cas_consumer/SemanticSearchCasIndexer.xml`
 - `%UIMA_HOME%/examples/descriptors/cas_consumer/XmiWriterCasConsumer.xml`

Set up parameters:

- Set the File System Collection Reader's “Input Directory” parameter to point to the `%UIMA_HOME%/examples/data` directory.
- Set the Semantic Search CAS Indexer's “Indexing Specification Descriptor” parameter to point to `%UIMA_HOME%/examples/descriptors/tutorial/search/MeetingIndexBuildSpec.xml`
- Set the Semantic Search CAS Indexer's “Index Dir” parameter to whatever directory into which you want the indexer to write its index files.

Warning: The Indexer *erases* old versions of the files it creates in this directory.

- Set the XMI Writer CAS Consumer's “Output Directory” parameter to whatever directory into which you want to store the XMI files containing the results of your analysis for each document.

Click on the Run Button. Once the run completes, a statistics dialog should appear, in which you can see how much time was spent in each of the components involved in the run.

3.5.2. Semantic Search Query Tool

The Semantic Search component from UIMA on alphaWorks contains a simple tool for running queries against a semantic search index. After building an index as described in the previous section, you can launch this tool by running the shell script: `semanticSearch`, found in the `/bin` subdirectory of the Semantic Search UIMA install, at the command prompt. If you are using Eclipse, and have installed the UIMA examples, there will be a Run configuration you can use to conveniently launch this, called `UIMA Semantic Search`. This will display the following screen:

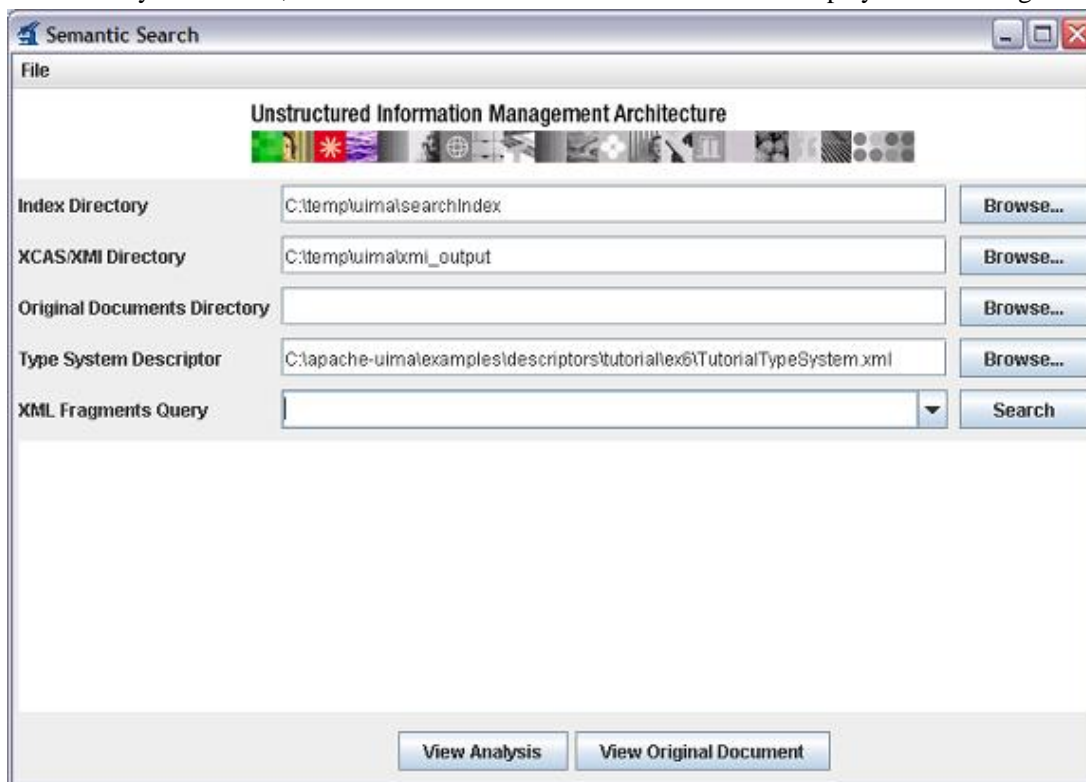

Configure the fields on this screen as follows:

- Set the “Index Directory” to the directory where you built your index. This is the same value that you supplied for the “Index Dir” parameter of the Semantic Search CAS Indexer in the CPE Configurator.
- Set the “XMI/XCAS Directory” to the directory where you stored the results of your analysis. This is the same value that you supplied for the “Output Directory” parameter of XMI Writer CAS Consumer in the CPE Configurator.
- Optionally, set the “Original Documents Directory” to the directory containing the original plain text documents that were analyzed and indexed. This is only needed for the "View Original Document" button.
- Set the “Type System Descriptor” to the location of the descriptor that describes your type system. For this example, this will be `%UIMA_HOME%/examples/ descriptors/ tutorial/ex4/TutorialTypeSystem.xml`

Now, in the “XML Fragments” field, you can type in single words or XML queries where the XML tags correspond to the labels in the index build specification file (e.g. `<Meeting>UIMA</`

Meeting>). XML Fragments are described in the documentation for the semantic search engine component on <http://www.alphaworks.ibm.com/tech/uima>.

After you enter a query and click the “Search” button, a list of hits will appear. Select one of the documents and click “View Analysis” to view the document in the UIMA Annotation Viewer.

The source code for the Semantic Search query program is in `examples/src/com/ibm/apache-uima/search/examples/SemanticSearchGUI.java`. A simple command-line query program is also provided in `examples/src/com/ibm/apache-uima/search/examples/SemanticSearch.java`. Using these as a model, you can build a query interface from your own application. For details on the Semantic Search Engine query language and interface, see the documentation for the semantic search engine component on <http://www.alphaworks.ibm.com/tech/uima>.

3.6. Working with Remote Services

The UIMA SDK allows you to easily take any Analysis Engine or CAS Consumer and deploy it as a service. That Analysis Engine or CAS Consumer can then be called from a remote machine using various network protocols.

The UIMA SDK provides support for two communications protocols:

- SOAP, the standard Web Services protocol
- Vinci, a lightweight version of SOAP, included as a part of Apache UIMA.

The UIMA framework can make use of these services in two different ways:

1. An Analysis Engine can create a proxy to a remote service; this proxy acts like a local component, but connects to the remote. The proxy has limited error handling and retry capabilities. Both Vinci and SOAP are supported.
2. A Collection Processing Engine can specify non-Integrated mode (see Section 2.5, “Deploying a CPE”). The CPE provides more extensive error recovery capabilities. This mode only supports the Vinci communications protocol.

3.6.1. Deploying a UIMA Component as a SOAP Service

To deploy a UIMA component as a SOAP Web Service, you need to first install the following software components:

- Apache Tomcat 5.0 or 5.5 (<http://jakarta.apache.org/tomcat/>)
- Apache Axis 1.3 or 1.4 (<http://ws.apache.org/axis/>)

Later versions of these components will likely also work, but have not been tested.

Next, you need to do the following setup steps:

- Set the `CATALINA_HOME` environment variable to the location where Tomcat is installed.
- Copy all of the JAR files from `%UIMA_HOME%/lib` to the `%CATALINA_HOME%/webapps/axis/WEB-INF/lib` in your installation.
- Copy your JAR files for the UIMA components that you wish to `%CATALINA_HOME%/webapps/axis/WEB-INF/lib` in your installation.
- **IMPORTANT:** any time you add JAR files to Tomcat (for instance, in the above 2 steps), you must shutdown and restart Tomcat before it “notices” this. So now, please shutdown and restart Tomcat.

- All the Java classes for the UIMA Examples are packaged in the `uima-examples.jar` file which is included in the `%UIMA_HOME%/lib` folder.
- In addition, if an annotator needs to locate resource files in the classpath, those resources must be available in the Axis classpath, so copy these also to `%CATALINA_HOME%/webapps/axis/WEB-INF/classes`.

As an example, if you are deploying the `GovernmentTitleRecognizer` (found in `examples/descriptors/analysis_engine/GovernmentOfficialRecognizer_RegEx_TAE`) as a SOAP service, you need to copy the file `examples/resources/GovernmentTitlePatterns.dat` into `../WEB-INF/classes`.

Test your installation of Tomcat and Axis by starting Tomcat and going to `http://localhost:8080/axis/happyaxis.jsp` in your browser. Check to be sure that this reports that all of the required Axis libraries are present. One common missing file may be `activation.jar`, which you can get from `java.sun.com`.

After completing these setup instructions, you can deploy Analysis Engines or CAS Consumers as SOAP web services by using the `deploytool` utility, which is located in the `/bin` directory of the UIMA SDK. `deploytool` is a command line program utility that takes as an argument a web services deployment descriptors (WSDD file); example WSDD files are provided in the `examples/deploy/soap` directory of the UIMA SDK. Deployment Descriptors have been provided for deploying and undeploying some of the example Analysis Engines that come with the SDK.

As an example, the WSDD file for deploying the example Person Title annotator looks like this (important parts are in bold italics):

```
<deployment name="PersonTitleAnnotator"
  xmlns="http://xml.apache.org/axis/wsdd/"
  xmlns:java="http://xml.apache.org/axis/wsdd/providers/java">

  <service name="urn:PersonTitleAnnotator" provider="java:RPC">

    <parameter name="scope" value="Request"/>

    <parameter name="className"
      value="org.apache.uima.reference_impl.analysis_engine
        .service.soap.AxisAnalysisEngineService_impl"/>

    <parameter name="allowedMethods" value="getMetaData process"/>
    <parameter name="allowedRoles" value="*/>
    <parameter name="resourceSpecifierPath"
      value="C:/Program Files/apache/uima/examples/
        descriptors/analysis_engine/PersonTitleAnnotator.xml" />

    <parameter name="numInstances" value="3"/>

    <!-- Type Mappings omitted from this document;
      you will not need to edit them. -->

    <typeMapping .../>
    <typeMapping .../>
    <typeMapping .../>

  </service>

</deployment>
```

To modify this WSDD file to deploy your own Analysis Engine or CAS Consumer, just replace the areas indicated in bold italics (deployment name, service name, and resource specifier path) with values appropriate for your component.

The `numInstances` parameter specifies how many instances of your Analysis Engine or CAS Consumer will be created. This allows your service to support multiple clients concurrently. When a new request comes in, if all of the instances are busy, the new request will wait until an instance becomes available.

To deploy the Person Title annotator service, issue the following command:

```
C:/Program Files/apache/uima/bin>deploytool
../examples/deploy/soap/Deploy_PersonTitleAnnotator.wsdd
```

Test if the deployment was successful by starting up a browser, pointing it to your Tomcat installation's "axis" webpage (e.g., <http://localhost:8080/axis>) and clicking on the List link. This should bring up a page which shows the deployed services, where you should see the service you just deployed.

The other components can be deployed by replacing `Deploy_PersonTitleAnnotator.wsdd` with one of the other Deploy descriptors in the deploy directory. The `deploytool` utility can also undeploy services when passed one of the Undeploy descriptors.

Note: The `deploytool` shell script assumes that the web services are to be installed at <http://localhost:8080/axis>. If this is not the case, you will need to update the shell script appropriately.

Once you have deployed your component as a web service, you may call it from a remote machine. See [Section 3.6.3, "Calling a UIMA Service" \[84\]](#) for instructions.

3.6.2. Deploying a UIMA Component as a Vinci Service

There are no software prerequisites for deploying a Vinci service. The necessary libraries are part of the UIMA SDK. However, before you can use Vinci services you need to deploy the Vinci Naming Service (VNS), as described in [section Section 3.6.5, "The Vinci Naming Services \(VNS\)" \[86\]](#).

To deploy a service, you have to insure any components you want to include can be found on the class path. One way to do this is to set the environment variable `UIMA_CLASSPATH` to the set of class paths you need for any included components. Then run the `startVinciService` shell script, which is located in the `bin` directory, and pass it the path to a Vinci deployment descriptor, for example: `C:UIMA>bin/startVinciService ../examples/deploy/vinci/Deploy_PersonTitleAnnotator.xml`. If you are running Eclipse, and have the `uimaj-examples` project in your workspace, you can use the Eclipse Menu → Run → Run... and then pick "UIMA Start Vinci Service".

This example deployment descriptor looks like:

```
<deployment name="Vinci Person Title Annotator Service">
  <service name="uima.annotator.PersonTitleAnnotator" provider="vinci">
    <parameter name="resourceSpecifierPath"
      value="C:/Program Files/apache/uima/examples/descriptors/
        analysis_engine/PersonTitleAnnotator.xml"/>
  </service>
</deployment>
```

```
<parameter name="numInstances" value="1" />

<parameter name="serverSocketTimeout" value="120000" />

</service>

</deployment>
```

To modify this deployment descriptor to deploy your own Analysis Engine or CAS Consumer, just replace the areas indicated in bold italics (deployment name, service name, and resource specifier path) with values appropriate for your component.

The `numInstances` parameter specifies how many instances of your Analysis Engine or CAS Consumer will be created. This allows your service to support multiple clients concurrently. When a new request comes in, if all of the instances are busy, the new request will wait until an instance becomes available.

The `serverSocketTimeout` parameter specifies the number of milliseconds (default = 5 minutes) that the service will wait between requests to process something. After this amount of time, the server will presume the client may have gone away - and it “cleans up”, releasing any resources it is holding. The next call to process on the service will result in a cycle which will cause the client to re-establish its connection with the service (some additional overhead).

There are two additional parameters that you can add to your deployment descriptor:

- `<parameter name="threadPoolMinSize" value="[Integer]" />`: Specifies the number of threads that the Vinci service creates on startup in order to serve clients' requests.
- `<parameter name="threadPoolMaxSize" value="[Integer]" />`: Specifies the maximum number of threads that the Vinci service will create. When the number of concurrent requests exceeds the `threadPoolMinSize`, additional threads will be created to serve requests, until the `threadPoolMaxSize` is reached.

The `startVinciService` script takes two additional optional parameters. The first one overrides the value of the `VNS_HOST` environment variable, allowing you to specify the name server to use. The second parameter if specified needs to be a unique (on this server) non-negative number, specifying the instance of this service. When used, this number allows multiple instances of the same named service to be started on one server; they will all register with the Vinci name service and be made available to client requests.

Once you have deployed your component as a web service, you may call it from a remote machine. See [Section 3.6.3, “Calling a UIMA Service” \[84\]](#) for instructions.

3.6.3. How to Call a UIMA Service

Once an Analysis Engine or CAS Consumer has been deployed as a service, it can be used from any UIMA application, in the exact same way that a local Analysis Engine or CAS Consumer is used. For example, you can call an Analysis Engine service from the Document Analyzer or use the CPE Configurator to build a CPE that includes Analysis Engine and CAS Consumer services.

To do this, you use a *service client descriptor* in place of the usual Analysis Engine or CAS Consumer Descriptor. A service client descriptor is a simple XML file that indicates the location of the remote service and a few parameters. Example service client descriptors are provided in the UIMA SDK under the directories `examples/descriptors/soapService` and `examples/descriptors/vinciService`. The contents of these descriptors are explained below.

Also, before you can call a SOAP service, you need to have the necessary Axis JAR files in your classpath. If you use any of the scripts in the `bin` directory of the UIMA installation to launch your application, such as `documentAnalyzer`, these JARs are added to the classpath, automatically, using the `CATALINA_HOME` environment variable. The required files are the following (all part of the Apache Axis download)

- `activation.jar`
- `axis.jar`
- `commons-discovery.jar`
- `commons-logging.jar`
- `jaxrpc.jar`
- `saaj.jar`

3.6.3.1. SOAP Service Client Descriptor

The descriptor used to call the `PersonTitleAnnotator` SOAP service from the example above is:

```
<uriSpecifier xmlns="http://uima.apache.org/resourceSpecifier">
  <resourceType>AnalysisEngine</resourceType>
  <uri>http://localhost:8080/axis/services/urn:PersonTitleAnnotator</uri>
  <protocol>SOAP</protocol>
  <timeout>60000</timeout>
</uriSpecifier>
```

The `<resourceType>` element must contain either `AnalysisEngine` or `CasConsumer`. This specifies what type of component you expect to be at the specified service address.

The `<uri>` element describes which service to call. It specifies the host (`localhost`, in this example) and the service name (`urn:PersonTitleAnnotator`), which must match the name specified in the deployment descriptor used to deploy the service.

3.6.3.2. Vinci Service Client Descriptor

To call a Vinci service, a similar descriptor is used:

```
<uriSpecifier xmlns="http://uima.apache.org/resourceSpecifier">
  <resourceType>AnalysisEngine</resourceType>
  <uri>uima.annot.PersonTitleAnnotator</uri>
  <protocol>Vinci</protocol>
  <timeout>60000</timeout>
  <parameters>
    <parameter name="VNS_HOST" value="some.internet.ip.name-or-address"/>
    <parameter name="VNS_PORT" value="9000"/>
  </parameters>
</uriSpecifier>
```

Note that Vinci uses a centralized naming server, so the host where the service is deployed does not need to be specified. Only a name (`uima.annot.PersonTitleAnnotator`) is given, which must match the name specified in the deployment descriptor used to deploy the service.

The host and/or port where your Vinci Naming Service (VNS) server is running can be specified by the optional `<parameter>` elements. If not specified, the value is taken from the specification given your Java command line (if present) using `-DVNS_HOST=<host>` and `-DVNS_PORT=<port>` system arguments. If not specified on the Java command line, defaults are used: `localhost` for the `VNS_HOST`, and `9000` for the `VNS_PORT`. See the next section for details on setting up a VNS server.

3.6.4. Restrictions on remotely deployed services

Remotely deployed services are started on remote machines, using UIMA component descriptors on those remote machines. These descriptors supply any configuration and resource parameters for the service (configuration parameters are not transmitted from the calling instance to the remote one). Likewise, the remote descriptors supply the type system specification for the remote annotators that will be run (the type system of the calling instance is not transmitted to the remote one).

The remote service wrapper, when it receives a CAS from the caller, instantiates it for the remote service, making instances of all types which the remote service specifies. Other instances in the incoming CAS for types which the remote service has no type specification for are kept aside, and when the remote service returns the CAS back to the caller, these type instances are re-merged back into the CAS being transmitted back to the caller. Because of this design, a remote service which doesn't declare a type system won't receive any type instances.

Note: This behavior may change in future releases, to one where configuration parameters and / or type systems are transmitted to remote services.

3.6.5. The Vinci Naming Services (VNS)

Vinci consists of components for building network-accessible services, clients for accessing those services, and an infrastructure for locating and managing services. The primary infrastructure component is the Vinci directory, known as VNS (for Vinci Naming Service).

On startup, Vinci services locate the VNS and provide it with information that is used by VNS during service discovery. Vinci service provides the name of the host machine on which it runs, and the name of the service. The VNS internally creates a binding for the service name and returns the port number on which the Vinci service will wait for client requests. This VNS stores its bindings in a filesystem in a file called `vns.services`.

In Vinci, services are identified by their service name. If there is more than one physical service with the same service name, then Vinci assumes they are equivalent and will route queries to them randomly, provided that they are all running on different hosts. You should therefore use a unique service name if you don't want to conflict with other services listed in whatever VNS you have configured jVinci to use.

3.6.5.1. Starting VNS

To run the VNS use the `startVNS` script found in the `bin` directory of the UIMA installation, or launch it from Eclipse. If you've installed the `uimaj-examples` project, it will supply a pre-configured launch script you can access in Eclipse by selecting `Menu → Run → Run...` and picking "UIMA Start VNS".

Note: VNS runs on port 9000 by default so please make sure this port is available. If you see the following exception:

```
java.net.BindException: Address already in use:
JVM_Bind
```

it indicates that another process is running on port 9000. In this case, add the parameter `-p <port>` to the `startVNS` command, using `<port>` to specify an alternative port to use.

workspace, you will also find an Eclipse launcher named “UIMA Start Vinci Service” you can use.) For the script, the environmental variable `VNS_HOST` should be set to the name or IP address of the machine hosting the Vinci Naming Service. The default is `localhost`, the machine the service is deployed on. This name can also be passed as the second argument to the `startVinciService` script. The default port for VNS is 9000 but can be overridden with the `VNS_PORT` environmental variable.

If you write your own startup script, to define Vinci’s default VNS you must provide the following JVM parameters:

```
java -DVNS_HOST=localhost -DVNS_PORT=9000 ...
```

The above setting is for the VNS running on the same machine as the service. Of course one can deploy the VNS on a different machine and the JVM parameter will need to be changed to this:

```
java -DVNS_HOST=<host> -DVNS_PORT=9000 ...
```

where “<host>” is a machine name or its IP where the VNS is running.

Note: VNS runs on port 9000 by default. If you see the following exception:

```
(WARNING) Unexpected exception:
org.apache.vinci.transport.ServiceDownException:
    VNS inaccessible: java.net.Connect
Exception: Connection refused: connect
```

then, perhaps the VNS is not running OR the VNS is running but it is using a different port. To correct the latter, set the environmental variable `VNS_PORT` to the correct port before starting the service.

To get the right port check the VNS output for something similar to the following:

```
[10/6/04 3:44 PM | main] Serving on port : 9000
```

It is printed by the VNS on startup.

3.6.6. Configuring Timeout Settings

UIMA has several timeout specifications, summarized here. The timeouts associated with remote services are discussed below. In addition there are timeouts that can be specified for:

- **Acquiring an empty CAS from a CAS Pool:** See [Section 3.2.5, “Multi-threaded Applications” \[70\]](#).
- **Reassembling chunks of a large document** See [Section 3.7, “CPE Operational Parameters”](#)

If your application uses remote UIMA services it is important to consider how to set the *timeout* values appropriately. This is particularly important if your service can take a long time to process each request.

There are two types of timeout settings in UIMA, the *client timeout* and the *server socket timeout*. The client timeout is usually the most important, it specifies how long that client is willing to wait for the service to process each CAS. The client timeout can be specified for both Vinci and SOAP.

The server socket timeout (Vinci only) specifies how long the service holds the connection open between calls from the client. After this amount of time, the server will presume the client may have gone away - and it “cleans up”, releasing any resources it is holding. The next call to process on the service will cause the client to re-establish its connection with the service (some additional overhead).

3.6.6.1. Setting the Client Timeout

The way to set the client timeout is different depending on what deployment mode you use in your CPE (if any).

If you are using the default “integrated” deployment mode in your CPE, or if you are not using a CPE at all, then the client timeout is specified in your Service Client Descriptor (see [Section 3.6.3, “Calling a UIMA Service” \[84\]](#)). For example:

```
<uriSpecifier xmlns="http://uima.apache.org/resourceSpecifier">
  <resourceType>AnalysisEngine</resourceType>
  <uri>uima.annot.PersonTitleAnnotator</uri>
  <protocol>Vinci</protocol>
  <timeout>60000</timeout>
  <parameters>
    <parameter name="VNS_HOST" value="some.internet.ip.name-or-address" />
    <parameter name="VNS_PORT" value="9000" />
  </parameters>
</uriSpecifier>
```

The client timeout in this example is 60000. This value specifies the number of milliseconds that the client will wait for the service to respond to each request. In this example, the client will wait for one minute.

If the service does not respond within this amount of time, processing of the current CAS will abort. If you called the `AnalysisEngine.process` method directly from your application, an Exception will be thrown. If you are running a CPE, what happens next is dependent on the error handling settings in your CPE descriptor (see [Section 3.6.1.7, “<errorHandling> Element”](#)). The default action is for the CPE to terminate, but you can override this.

If you are using the “managed” or “non-managed” deployment mode in your CPE, then the client timeout is specified in your CPE descriptor's `errorHandling` element. For example:

```
<errorHandling>
  <maxConsecutiveRestarts .../>
  <errorRateThreshold .../>
  <timeout max="60000" />
</errorHandling>
```

As in the previous example, the client timeout is set to 60000, and this specifies the number of milliseconds that the client will wait for the service to respond to each request.

If the service does not respond within the specified amount of time, the action is determined by the settings for `maxConsecutiveRestarts` and `errorRateThreshold`. These settings support such things as restarting the process (for “managed” deployment mode), dropping and reestablishing the connection (for “non-managed” deployment mode), and removing the offending service from the pipeline. See [Section 3.6.1.7, “<errorHandling> Element”](#) for details.

Note that the client timeout does not apply to the `GetMetaData` request that is made when the client first connects to the service. This call is typically very fast and does not need a large timeout

(the default is 60 seconds). However, if many clients are competing for a small number of services, it may be necessary to increase this value. See Section 2.7, “Service Client Descriptors”

3.6.6.2. Setting the Server Socket Timeout

The Server Socket Timeout applies only to Vinci services, and is specified in the Vinci deployment descriptor as discussed in section [Section 3.6.2, “Deploying as a Vinci Service” \[83\]](#). For example:

```
<deployment name="Vinci Person Title Annotator Service">
  <service name="uima.annotator.PersonTitleAnnotator" provider="vinci">
    <parameter name="resourceSpecifierPath"
      value="C:/Program Files/apache/uima/examples/descriptors/
        analysis_engine/PersonTitleAnnotator.xml"/>
    <parameter name="numInstances" value="1"/>
    <parameter name="serverSocketTimeout" value="120000"/>
  </service>
</deployment>
```

The server socket timeout here is set to 120000 milliseconds, or two minutes. This parameter specifies how long the service will wait between requests to process something. After this amount of time, the server will presume the client may have gone away - and it “cleans up”, releasing any resources it is holding. The next call to process on the service will cause the client to re-establish its connection with the service (some additional overhead). The service may print a “Read Timed Out” message to the console when the server socket timeout elapses.

In most cases, it is not a problem if the server socket timeout elapses. The client will simply reconnect. However, if you notice “Read Timed Out” messages on your server console, followed by other connection problems, it is possible that the client is having trouble reconnecting for some reason. In this situation it may help increase the stability of your application if you increase the server socket timeout so that it does not elapse during actual processing.

3.7. Increasing performance using parallelism

There are several ways to exploit parallelism to increase performance in the UIMA Framework. These range from running with additional threads within one Java virtual machine on one host (which might be a multi-processor or hyper-threaded host) to deploying analysis engines on a set of remote machines.

The Collection Processing facility in UIMA provides the ability to scale the pipe-line of analysis engines. This scale-out runs multiple threads within the Java virtual machine running the CPM, one for each pipe in the pipe-line. To activate it, in the `<casProcessors>` descriptor element, set the attribute `processingUnitThreadCount`, which specifies the number of replicated processing pipelines, to a value greater than 1, and insure that the size of the CAS pool is equal to or greater than this number (the attribute of `<casProcessors>` to set is `casPoolSize`). For more details on these settings, see Section 3.6, “CAS Processors”.

For deployments that incorporate remote analysis engines in the Collection Manager pipe-line, running on multiple remote hosts, scale-out is supported which uses the Vinci naming service. If

multiple instances of a service with the same name, but running on different hosts, are registered with the Vinci Name Server, it will assign these instances to incoming requests.

There are two modes supported: a “random” assignment, and a “exclusive” one. The “random” mode distributes load using an algorithm that selects a service instance at random. The UIMA framework supports this only for the case where all of the instances are running on unique hosts; the framework does not support starting 2 or more instances on the same host.

The exclusive mode dedicates a particular remote instance to each Collection Manager pip-line instance. This mode is enabled by adding a configuration parameter in the <casProcessor> section of the CPE descriptor:

```
<deploymentParameters>
  <parameter name="service-access" value="exclusive" />
</deploymentParameters>
```

If this is not specified, the “random” mode is used.

In addition, remote UIMA engine services can be started with a parameter that specifies the number of instances the service should support (see the <parameter name="numInstances"> XML element in remote deployment descriptor [Section 3.6, “Working with Remote Services” \[81\]](#)). Specifying more than one causes the service wrapper for the analysis engine to use multi-threading (within the single Java Virtual Machine – which can take advantage of multi-processor and hyper-threaded architectures).

Note: When using Vinci in “exclusive” mode (see service access under [Section 3.6.1.5, “<deploymentParameters> Element”](#)), only one thread is used. To achieve multi-processing on a server in this case, use multiple instances of the service, instead of multiple threads (see [Section 3.6.2, “Deploying as a Vinci Service” \[83\]](#)).

3.8. Monitoring AE Performance using JMX

As of version 2, UIMA supports remote monitoring of Analysis Engine performance via the Java Management Extensions (JMX) API. JMX is a standard part of the Java Runtime Environment v5.0; there is also a reference implementation available from Sun for Java 1.4. An introduction to JMX is available from Sun here: <http://java.sun.com/developer/technicalArticles/J2SE/jmx.html>. When you run a UIMA with a JVM that supports JMX, the UIMA framework will automatically detect the presence of JMX and will register *MBeans* that provide access to the performance statistics.

Note: The Sun JVM supports local monitoring; for others you can configure your application for remote monitoring (even when on the same host) by specifying a unique port number, e.g. `-Dcom.sun.management.jmxremote.port=1098`
`-Dcom.sun.management.jmxremote.authenticate=false`
`Dcom.sun.management.jmxremote.ssl=false`

Now, you can use any JMX client to view the statistics. JDK 5.0 or later provides a standard client that you can use. Simply open a command prompt, make sure the JDK bin directory is in your path, and execute the `jconsole` command. This should bring up a window allowing you to select one of the local JMX-enabled applications currently running, or to enter a remote (or local) host and port, e.g. `localhost:1098`. The next screen will show a summary of information about the Java process that you connected to. Click on the “MBeans” tab, then expand “org.apache.uima” in the tree at the left. You should see a view like this:

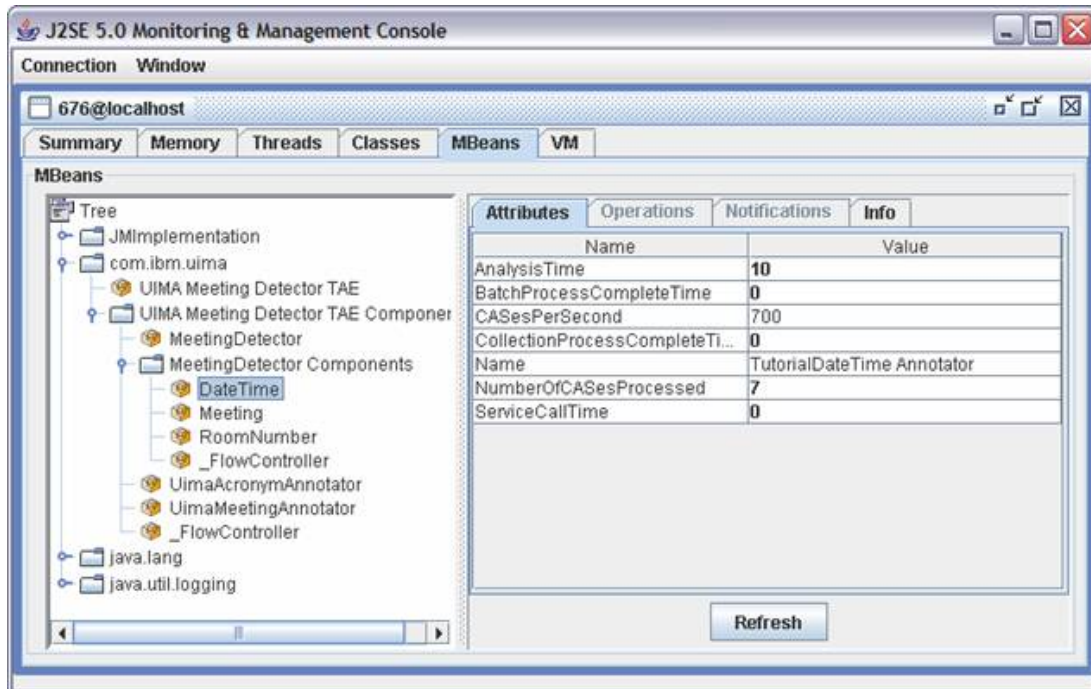

Each of the nodes under “org.apache.uima” in the tree represents one of the UIMA Analysis Engines in the application that you connected to. You can select one of the analysis engines to view its performance statistics in the view at the right.

Probably the most useful statistic is “CASes Per Second”, which is the number of CASes that this AE has processed divided by the amount of time spent in the AE’s process method, in seconds. Note that this is the total elapsed time, not CPU time. Even so, it can be useful to compare the “CASes Per Second” numbers of all of your Analysis Engines to discover where the bottlenecks occur in your application.

The AnalysisTime, BatchProcessCompleteTime, and CollectionProcessCompleteTime properties show the total elapsed time, in milliseconds, that has been spent in the AnalysisEngine’s process(), batchProcessComplete(), and collectionProcessComplete() methods, respectively. (Note that for CAS Multipliers, time spent in the hasNext() and next() methods is also counted towards the AnalysisTime.)

Note that once your UIMA application terminates, you can no longer view the statistics through the JMX console. If you want to use JMX to view processes that have completed, you will need to write your application so that the JVM remains running after processing completes, waiting for some user signal before terminating.

It is possible to override the default JMX MBean names UIMA uses, for example to better organize the UIMA MBeans with respect to MBeans exposed by other parts of your application. This is done using the AnalysisEngine.PARAM_MBEAN_NAME_PREFIX additional parameter when creating your AnalysisEngine:

```
//set up Map with custom JMX MBean name prefix
Map paramMap = new HashMap();
paramMap.put(AnalysisEngine.PARAM_MBEAN_NAME_PREFIX,
    "org.myorg:category=MyApp");

// create Analysis Engine
```

```
AnalysisEngine ae =
    UIMAFramework.produceAnalysisEngine(specifier, paramMap);
```

Similarly, you can use the `AnalysisEngine.PARAM_MBEAN_SERVER` parameter to specify a particular instance of a JMX MBean Server with which UIMA should register the MBeans. If no specified then the default is to register with the platform MBeanServer (Java 5+ only).

More information on JMX can be found in the [Java 5 documentation](#)².

3.9. Performance Tuning Options

There are a small number of performance tuning options available to influence the runtime behavior of UIMA applications. Performance tuning options need to be set programmatically when an analysis engine is created. You simply create a Java Properties object with the relevant options and pass it to the UIMA framework on the call to create an analysis engine. Below is an example.

```
XMLParser parser = UIMAFramework.getXMLParser();
ResourceSpecifier spec = parser.parseResourceSpecifier(
    new XMLInputSource(descriptorFile));
// Create a new properties object to hold the settings.
Properties performanceTuningSettings = new Properties();
// Set the initial CAS heap size.
performanceTuningSettings.setProperty(
    UIMAFramework.CAS_INITIAL_HEAP_SIZE,
    "1000000");
// Disable JCas cache.
performanceTuningSettings.setProperty(
    UIMAFramework.JCAS_CACHE_ENABLED,
    "false");
// Create a wrapper properties object that can
// be passed to the framework.
Properties additionalParams = new Properties();
// Set the performance tuning properties as value to
// the appropriate parameter.
additionalParams.put(
    Resource.PARAM_PERFORMANCE_TUNING_SETTINGS,
    performanceTuningSettings);
// Create the analysis engine with the parameters.
// The second, unused argument here is a custom
// resource manager.
this.ae = UIMAFramework.produceAnalysisEngine(
    spec, null, additionalParams);
```

The following options are supported:

- `UIMAFramework.JCAS_CACHE_ENABLED`: allows you to disable the JCas cache (true/false). The JCas cache is an internal datastructure that caches any JCas object created by the CAS. This may result in better performance for applications that make extensive use of the JCas, but also incurs a steep memory overhead. If you're processing large documents and have memory issues, you should disable this option. In general, just try running a few experiments to see what setting works better for your application. The JCas cache is enabled by default.

² http://java.sun.com/j2se/1.5.0/docs/api/javax/management/package-summary.html#package_description

- `UIMAFramework.CAS_INITIAL_HEAP_SIZE`: set the initial CAS heap size in number of cells (integer valued). The CAS uses 32bit integer cells, so four times the initial size is the approximate minimum size of the CAS in bytes. This is another space/time trade-off as growing the CAS heap is relatively expensive. On the other hand, setting the initial size too high is wasting memory. Unless you know you are processing very small or very large documents, you should probably leave this option unchanged.
- `UIMAFramework.PROCESS_TRACE_ENABLED`: enable the process trace mechanism (true/false). When enabled, UIMA tracks the time spent in individual components of an aggregate AE or CPE. For more information, see the API documentation of `org.apache.uima.util.ProcessTrace`.
- `UIMAFramework.SOCKET_KEEPALIVE_ENABLED`: enable socket KeepAlive (true/false). This setting is currently only supported by Vinci clients. Defaults to `true`.

Chapter 4. Flow Controller Developer's Guide

A Flow Controller is a component that plugs into an Aggregate Analysis Engine. When a CAS is input to the Aggregate, the Flow Controller determines the order in which the components of that aggregate are invoked on that CAS. The ability to provide your own Flow Controller implementation is new as of release 2.0 of UIMA.

Flow Controllers may decide the flow dynamically, based on the contents of the CAS. So, as just one example, you could develop a Flow Controller that first sends each CAS to a Language Identification Annotator and then, based on the output of the Language Identification Annotator, routes that CAS to an Annotator that is specialized for that particular language.

4.1. Developing the Flow Controller Code

4.1.1. Flow Controller Interface Overview

Flow Controller implementations should extend from the `JCasFlowController_ImplBase` or `CasFlowController_ImplBase` classes, depending on which CAS interface they prefer to use. As with other types of components, the Flow Controller ImplBase classes define optional `initialize`, `destroy`, and `reconfigure` methods. They also define the required method `computeFlow`.

The `computeFlow` method is called by the framework whenever a new CAS enters the Aggregate Analysis Engine. It is given the CAS as an argument and must return an object which implements the `Flow` interface (the `Flow` object). The Flow Controller developer must define this object. It is the object that is responsible for routing this particular CAS through the components of the Aggregate Analysis Engine. For convenience, the framework provides basic implementation of flow objects in the classes `CasFlow_ImplBase` and `JCasFlow_ImplBase`; use the `JCas` one if you are using the `JCas` interface to the CAS.

The framework then uses the `Flow` object and calls its `next()` method, which returns a `Step` object (implemented by the UIMA Framework) that indicates what to do next with this CAS next. There are three types of steps currently supported:

- `SimpleStep`, which specifies a single Analysis Engine that should receive the CAS next.
- `ParallelStep`, which specifies that multiple Analysis Engines should receive the CAS next, and that the relative order in which these Analysis Engines execute does not matter. Logically, they can run in parallel. The runtime is not obligated to actually execute them in parallel, however, and the current implementation will execute them serially in an arbitrary order.
- `FinalStep`, which indicates that the flow is completed.

After executing the step, the framework will call the `Flow` object's `next()` method again to determine the next destination, and this will be repeated until the `Flow` Object indicates that processing is complete by returning a `FinalStep`.

The Flow Controller has access to a `FlowControllerContext`, which is a subtype of `UimaContext`. In addition to the configuration parameter and resource access provided by a `UimaContext`, the `FlowControllerContext` also gives access to the metadata for all of the Analysis Engines that the Flow Controller can route CASes to. Most Flow Controllers will need to use this information to make routing decisions. You can get a handle to the `FlowControllerContext` by calling the `getContext()` method defined

in `JCasFlowController_ImplBase` and `CasFlowController_ImplBase`. Then, the `FlowControllerContext.getAnalysisEngineMetaDataMap` method can be called to get a map containing an entry for each of the Analysis Engines in the Aggregate. The keys in this map are the same as the delegate analysis engine keys specified in the aggregate descriptor, and the values are the corresponding `AnalysisEngineMetaData` objects.

Finally, the Flow Controller has optional methods `addAnalysisEngines` and `removeAnalysisEngines`. These methods are intended to notify the Flow Controller if new Analysis Engines are available to route CASes to, or if previously available Analysis Engines are no longer available. However, the current version of the Apache UIMA framework does not support dynamically adding or removing Analysis Engines to/from an aggregate, so these methods are not currently called. Future versions may support this feature.

4.1.2. Example Code

This section walks through the source code of an example Flow Controller that simulates a simple version of the “Whiteboard” flow model. At each step of the flow, the Flow Controller looks it all of the available Analysis Engines that have not yet run on this CAS, and picks one whose input requirements are satisfied.

The Java class for the example is

`org.apache.uima.examples.flow.WhiteboardFlowController` and the source code is included in the UIMA SDK under the `examples/src` directory.

4.1.2.1. The WhiteboardFlowController Class

```
public class WhiteboardFlowController
    extends CasFlowController_ImplBase {
    public Flow computeFlow(CAS aCAS)
        throws AnalysisEngineProcessException {
        WhiteboardFlow flow = new WhiteboardFlow();
        // As of release 2.3.0, the following is not needed,
        // because the framework does this automatically
        // flow.setCas(aCAS);

        return flow;
    }

    class WhiteboardFlow extends CasFlow_ImplBase {
        // Discussed Later
    }
}
```

The `WhiteboardFlowController` extends from `CasFlowController_ImplBase` and implements the `computeFlow` method. The implementation of the `computeFlow` method is very simple; it just constructs a new `WhiteboardFlow` object that will be responsible for routing this CAS. The framework will add a handle to that CAS which it will later use to make its routing decisions.

Note that we will have one instance of `WhiteboardFlow` per CAS, so if there are multiple CASes being simultaneously processed there will not be any confusion.

4.1.2.2. The WhiteboardFlow Class

```
class WhiteboardFlow extends CasFlow_ImplBase {
```

```

private Set mAlreadyCalled = new HashSet();

public Step next() throws AnalysisEngineProcessException {
    // Get the CAS that this Flow object is responsible for routing.
    // Each Flow instance is responsible for a single CAS.
    CAS cas = getCas();

    // iterate over available AEs
    Iterator aeIter = getContext().getAnalysisEngineMetaDataMap().
        entrySet().iterator();
    while (aeIter.hasNext()) {
        Map.Entry entry = (Map.Entry) aeIter.next();
        // skip AEs that were already called on this CAS
        String aeKey = (String) entry.getKey();
        if (!mAlreadyCalled.contains(aeKey)) {
            // check for satisfied input capabilities
            //(i.e. the CAS contains at least one instance
            // of each required input
            AnalysisEngineMetaData md =
                (AnalysisEngineMetaData) entry.getValue();
            Capability[] caps = md.getCapabilities();
            boolean satisfied = true;
            for (int i = 0; i < caps.length; i++) {
                satisfied = inputsSatisfied(caps[i].getInputs(), cas);
                if (satisfied)
                    break;
            }
            if (satisfied) {
                mAlreadyCalled.add(aeKey);
                if (mLogger.isLoggable(Level.FINEST)) {
                    getContext().getLogger().log(Level.FINEST,
                        "Next AE is: " + aeKey);
                }
                return new SimpleStep(aeKey);
            }
        }
    }
    // no appropriate AEs to call - end of flow
    getContext().getLogger().log(Level.FINEST, "Flow Complete.");
    return new FinalStep();
}

private boolean inputsSatisfied(TypeOrFeature[] aInputs, CAS aCAS) {
    //implementation detail; see the actual source code
}
}

```

Each instance of the `WhiteboardFlowController` is responsible for routing a single CAS. A handle to the CAS instance is available by calling the `getCas()` method, which is a standard method defined on the `CasFlow_ImplBase` superclass.

Each time the `next` method is called, the Flow object iterates over the metadata of all of the available Analysis Engines (obtained via the call to `getContext().getAnalysisEngineMetaDataMap()`) and sees if the input types declared in an `AnalysisEngineMetaData` object are satisfied by the CAS (that is, the CAS contains at least one instance of each declared input type). The exact details of checking for instances of types in the CAS are not discussed here – see the `WhiteboardFlowController.java` file for the complete source.

When the Flow object decides which `AnalysisEngine` should be called next, it indicates this by creating a `SimpleStep` object with the key for that `AnalysisEngine` and returning it:

```
return new SimpleStep(aeKey);
```

The Flow object keeps a list of which Analysis Engines it has invoked in the `mAlreadyCalled` field, and never invokes the same Analysis Engine twice. Note this is not a hard requirement. It is acceptable to design a FlowController that invokes the same Analysis Engine more than once. However, if you do this you must make sure that the flow will eventually terminate.

If there are no Analysis Engines left whose input requirements are satisfied, the Flow object signals the end of the flow by returning a `FinalStep` object:

```
return new FinalStep();
```

Also, note the use of the logger to write tracing messages indicating the decisions made by the Flow Controller. This is a good practice that helps with debugging if the Flow Controller is behaving in an unexpected way.

4.2. Creating the Flow Controller Descriptor

To create a Flow Controller Descriptor in the CDE, use `File → New → Other → UIMA → Flow Controller Descriptor File`:

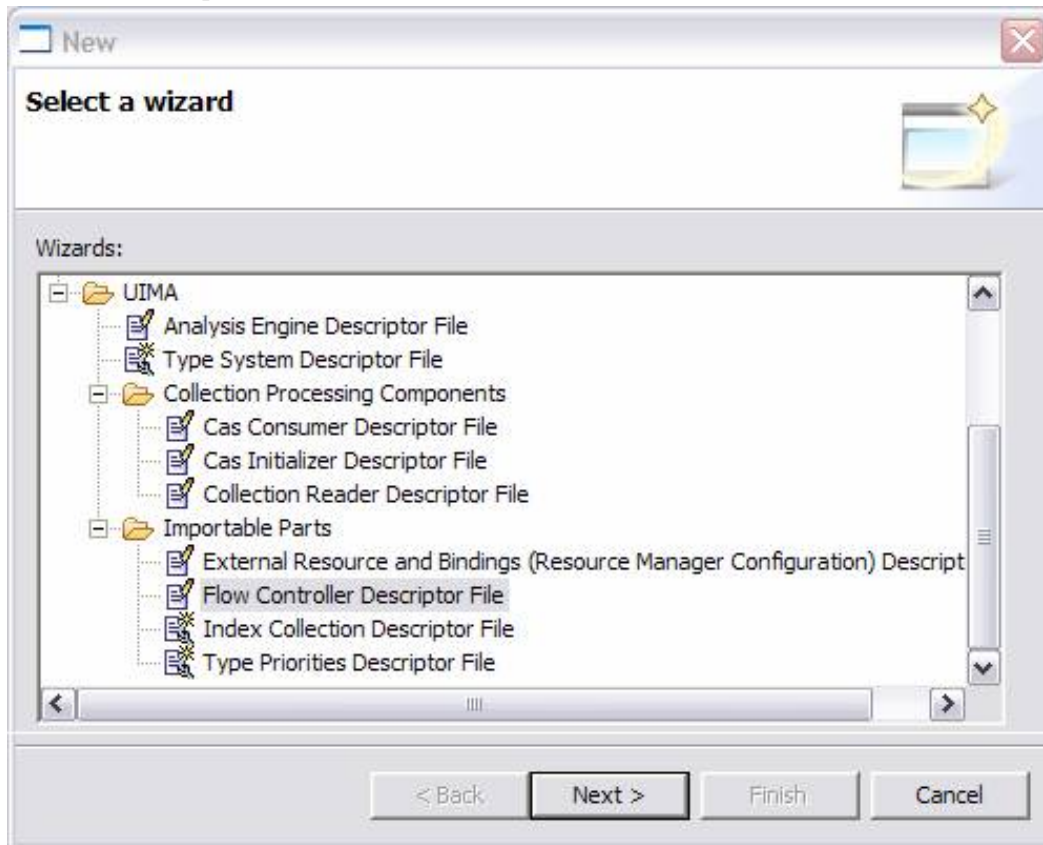

This will bring up the Overview page for the Flow Controller Descriptor:

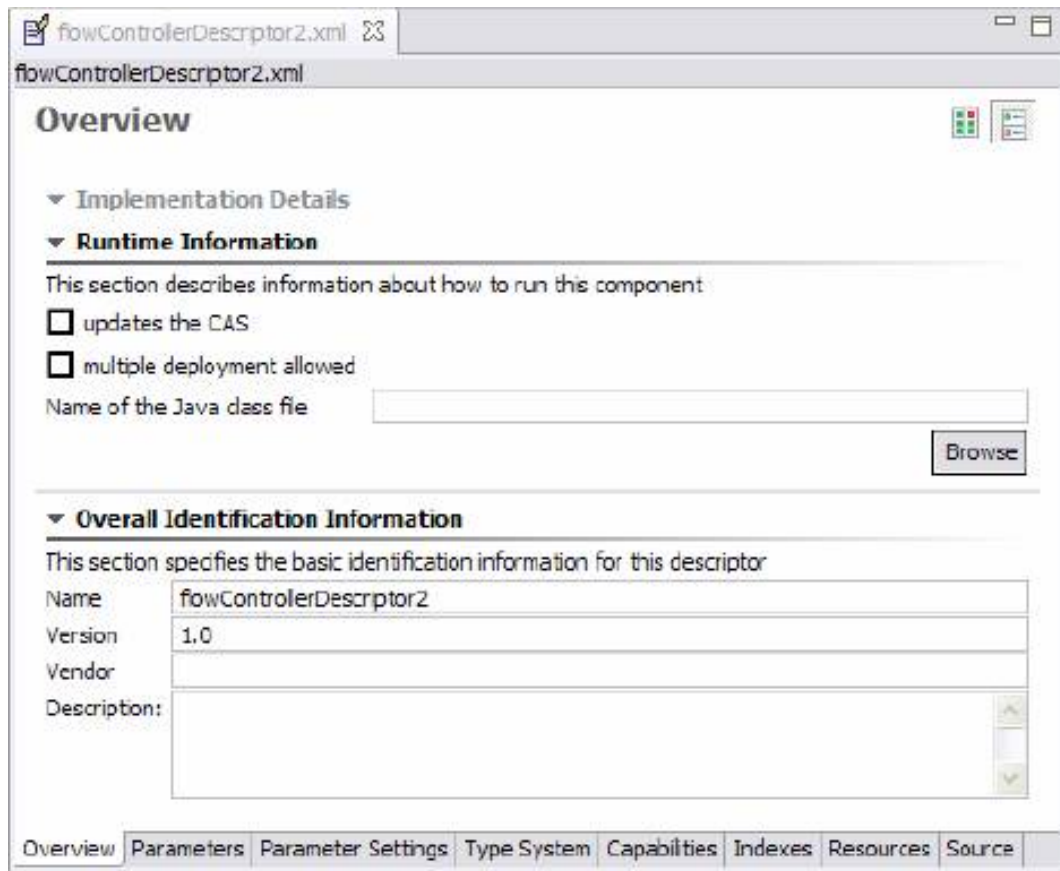

Type in the Java class name that implements the Flow Controller, or use the “Browse” button to select it. You must select a Java class that implements the `FlowController` interface.

Flow Controller Descriptors are very similar to Primitive Analysis Engine Descriptors – for example you can specify configuration parameters and external resources if you wish.

If you wish to edit a Flow Controller Descriptor by hand, see section Section 2.5, “Flow Controller Descriptors” for the syntax.

4.3. Adding a Flow Controller to an Aggregate Analysis Engine

To use a Flow Controller you must add it to an Aggregate Analysis Engine. You can only have one Flow Controller per Aggregate Analysis Engine. In the Component Descriptor Editor, the Flow Controller is specified on the Aggregate page, as a choice in the flow control kind - pick “User-defined Flow”. When you do, the Browse and Search buttons underneath become active, and allow you to specify an existing Flow Controller Descriptor, which when you select it, will be imported into the aggregate descriptor.

▼ Component Engine Flow

Choose a flow type and describe the execution order of your engines.
The table shows the delegates using their key names.

Flow Kind:

Flow Controller:

Key Name:

aeconfiguration3	<input type="button" value="Up"/> <input type="button" value="Down"/>
aeconfiguration8	
aeconfiguration32	
aeconfiguration3	

The key name is created automatically from the name element in the Flow Controller Descriptor being imported. If you need to change this name, you can do so by switching to the “Source” view using the bottom tabs, and editing the name in the XML source.

If you edit your Aggregate Analysis Engine Descriptor by hand, the syntax for adding a Flow Controller is:

```
<delegateAnalysisEngineSpecifiers>
  ...
</delegateAnalysisEngineSpecifiers>
<flowController key="[String]">
  <import .../>
</flowController>
```

As usual, you can use either in import by location or import by name – see Section 2.2, “Imports”.

The key that you assign to the FlowController can be used elsewhere in the Aggregate Analysis Engine Descriptor – in parameter overrides, resource bindings, and Sofa mappings.

4.4. Adding a Flow Controller to a Collection Processing Engine

Flow Controllers cannot be added directly to Collection Processing Engines. To use a Flow Controller in a CPE you first need to wrap the part of your CPE that requires complex flow control into an Aggregate Analysis Engine, and then add the Aggregate Analysis Engine to your CPE. The CPE’s deployment and error handling options can then only be configured for the entire Aggregate Analysis Engine as a unit.

4.5. Using Flow Controllers with CAS Multipliers

If you want your Flow Controller to work inside an Aggregate Analysis Engine that contains a CAS Multiplier (see Chapter 7, *CAS Multiplier Developer’s Guide*), there are additional things you must consider.

When your Flow Controller routes a CAS to a CAS Multiplier, the CAS Multiplier may produce new CASes that then will also need to be routed by the Flow Controller. When a new output CAS is produced, the framework will call the `newCasProduced` method on the Flow object that

was managing the flow of the parent CAS (the one that was input to the CAS Multiplier). The `newCasProduced` method must create a new Flow object that will be responsible for routing the new output CAS.

In the `CasFlow_ImplBase` and `JCasFlow_ImplBase` classes, the `newCasProduced` method is defined to throw an exception indicating that the Flow Controller does not handle CAS Multipliers. If you want your Flow Controller to properly deal with CAS Multipliers you must override this method.

If your Flow class extends `CasFlow_ImplBase`, the method signature to override is:

```
protected Flow newCasProduced(CAS newOutputCas, String producedBy)
```

If your Flow class extends `JCasFlow_ImplBase`, the method signature to override is:

```
protected Flow newCasProduced(JCas newOutputCas, String producedBy)
```

Also, there is a variant of `FinalStep` which can only be specified for output CASes produced by CAS Multipliers within the Aggregate Analysis Engine containing the Flow Controller. This version of `FinalStep` is produced by the calling the constructor with a `true` argument, and it causes the CAS to be immediately released back to the pool. No further processing will be done on it and it will not be output from the aggregate. This is the way that you can build an Aggregate Analysis Engine that outputs some new CASes but not others. Note that if you never want any new CASes to be output from the Aggregate Analysis Engine, you don't need to use this; instead just declare `<outputsNewCASes>false</outputsNewCASes>` in your Aggregate Analysis Engine Descriptor as described in Section 7.3.3, "Aggregate CAS Multipliers".

For more information on how CAS Multipliers interact with Flow Controllers, see Section 7.3.2, "CAS Multipliers and Flow Control".

4.6. Continuing the Flow When Exceptions Occur

If an exception occurs when processing a CAS, the framework may call the method

```
boolean continueOnFailure(String failedAeKey, Exception failure)
```

on the Flow object that was managing the flow of that CAS. If this method returns `true`, then the framework may continue to call the `next()` method to continue routing the CAS. If this method returns `false` (the default), the framework will not make any more calls to the `next()` method.

In the case where the last Step was a `ParallelStep`, if at least one of the destinations resulted in a failure, then `continueOnFailure` will be called to report one of the failures. If this method returns `true`, but one of the other destinations in the `ParallelStep` resulted in a failure, then the `continueOnFailure` method will be called again to report the next failure. This continues until either this method returns `false` or there are no more failures.

Note that it is possible for processing of a CAS to be aborted without this method being called. This method is only called when an attempt is being made to continue processing of the CAS following an exception, which may be an application configuration decision.

In any case, if processing is aborted by the framework for any reason, including because `continueOnFailure` returned `false`, the framework will call the `Flow.aborted()` method to allow the Flow object to clean up any resources.

For an example of how to continue after an exception, see the example code `org.apache.uima.examples.flow.AdvancedFixedFlowController`, in the `examples/src` directory of the UIMA SDK. This example also demonstrates the use of `ParallelStep`.

Chapter 5. Annotations, Artifacts, and Sofas

Up to this point, the documentation has focused on analyzing strings of Unicode text, producing subtypes of Annotations which reference offsets in those strings. This chapter generalizes this concept and shows how other kinds of artifacts can be handled, including non-text things like audio and images, and how you can define your own kinds of “annotations” for these.

5.1. Terminology

5.1.1. Artifact

The Artifact is the unstructured thing being analyzed by an annotator. It could be an HTML web page, an image, a video stream, a recorded audio conversation, an MPEG-4 stream, etc. Artifacts are often restructured in the course of processing to facilitate particular kinds of analysis. For instance, an HTML page may be converted into a “de-tagged” version. Annotators at different places in the pipeline may be analyzing different versions of the artifact.

5.1.2. Subject of Analysis — Sofa

Each representation of an Artifact is called a Subject of Analysis, abbreviated using the acronym “Sofa” which stands for Subject Of Analysis. Annotation metadata, which have explicit designations of sub-regions of the artifact to which they apply, are always associated with a particular Sofa. For instance, an annotation over text specifies two features, the begin and end, which represent the character offsets into the text string Sofa being analyzed.

Other examples of representations of Artifacts, which could be Sofas include: An HTML web page, a detagged web page, the translated text of that document, an audio or video stream, closed-caption text from a video stream, etc.

Often, there is one Sofa being analyzed in a CAS. The next chapter will show how UIMA facilitates working with multiple representations of an artifact at the same time, in the same CAS.

5.2. Formats of Sofa Data

Sofa data can be Java Unicode Strings, Feature Structure arrays of primitive types, or a URI which references remote data available via a network connection.

The arrays of primitive types can be things like byte arrays or float arrays, and are intended to be used for artifacts like audio data, image data, etc.

The URI form holds a URI specification String.

Note: Sofa data can be “serialized” using an XML format; when it is, the String data being serialized must not include invalid XML characters. See [Section 8.3.1, “Character Encoding Issues with XML Serialization”](#) [132].

5.3. Setting and Accessing Sofa Data

5.3.1. Setting Sofa Data

When a CAS is created, you can set its Sofa Data, just one time; this property insures that metadata describing regions of the Sofa remain valid. As a consequence, the following methods that set data for a given Sofa can only be called once for a given Sofa.

The following methods on the CAS set the Sofa Data to one of the 3 formats. Assume that the variable “aCas” holds a reference to a CAS:

```
aCas.setSofaDataString(document_text_string, mime_type_string);
aCas.setSofaDataArray(feature_structure_primitive_array, mime_type_string);
aCas.setSofaDataURI(uri_string, mime_type_string);
```

In addition, the method `aCas.setDocumentText(document_text_string)` may still be used, and is equivalent to `setSofaDataString(string, "text")`. The mime type is currently not used by the UIMA framework, but may be set and retrieved by user code.

Feature Structure primitive arrays are all the UIMA Array types except arrays of Feature Structures, Strings, and Booleans. Typically, these are arrays of bytes, but can be other types, such as floats, longs, etc.

The URI string should conform to the standard URI format.

5.3.2. Accessing Sofa Data

The analysis algorithms typically work with the Sofa data. The following methods on the CAS access the Sofa Data:

```
String          aCas.getDocumentText();
String          aCas.getSofaDataString();
FeatureStructure aCas.getSofaDataArray();
String          aCas.getSofaDataURI();
String          aCas.getSofaMimeType();
```

The `getDocumentText` and `getSofaDataString` return the same text string. The `getSofaDataURI` returns the URI itself, not the data the URI is pointing to. You can use standard Java I/O capabilities to get the data associated with the URI, or use the UIMA Framework Streaming method described next.

5.3.3. Accessing Sofa Data using a Java Stream

The framework provides a consistent method for accessing the Sofa data, independent of it being stored locally, or accessed remotely using the URI. Get a Java `InputStream` instance from the Sofa data using:

```
InputStream inputStream = aCas.getSofaDataStream();
```

- If the data is local, this method returns a `ByteArrayInputStream`. This stream provides bytes.
 - If the Sofa data was set using `setDocumentText` or `setSofaDataString`, the `String` is converted to bytes by using the UTF-8 encoding.

- If the Sofa data was set as a `DataArray`, the bytes in the data array are serialized, high-byte first.
- If the Sofa data was specified as a URI, this method returns the handle from `url.openStream()`. Java offers built-in support for several URI schemes including “FILE:”, “HTTP:”, “FTP:” and has an extensible mechanism, `URLStreamHandlerFactory`, for customizing access to an arbitrary URI. See more details at <http://java.sun.com/j2se/1.5.0/docs/api/java/net/URLStreamHandlerFactory.html>.

5.4. The Sofa Feature Structure

Information about a Sofa is contained in a special built-in Feature Structure of type `uima.cas.Sofa`. This feature structure is created and managed by the UIMA Framework; users must not create it directly. Although these Sofa type instances are implemented as standard feature structures, *generic CAS APIs can not be used to create Sofas or set their features*. Instead, Sofas are created implicitly by the creation of new CAS views. Similarly, Sofa features are set by CAS methods such as `cas.setDocumentText()`.

Features of the Sofa type include

- **SofaID:** Every Sofa in a CAS has a unique SofaID. SofaIDs are the primary handle for access. This ID is often the same as the name string given to the Sofa by the developer, but it can be mapped to a different name (see Section 6.4, “Sofa Name Mapping”).
- **Mime type:** This string feature can be used to describe the type of the data represented by a Sofa. It is not used by the framework; the framework provides APIs to set and get its value.
- **Sofa Data:** The Sofa data itself. This data can be resident in the CAS or it can be a reference to data outside the CAS.

5.5. Annotations

Annotators add meta data about a Sofa to the CAS. It is often useful to have this metadata denote a region of the Sofa to which it applies. For instance, assuming the Sofa is a `String`, the metadata might describe a particular substring as the name of a person. The built-in UIMA type, `uima.tcas.Annotation`, has two extra features that enable this - the `begin` and `end` features - which denote a character position offset into the text string being analyzed.

The concept of “annotations” can be generalized for non-string kinds of Sofas. For instance, an audio stream might have an audio annotation which describes sounds regions in terms of floating point time offsets in the Sofa. An image annotation might use two pairs of x,y coordinates to define the region the annotation applies to.

5.5.1. Built-in Annotation types

The built-in CAS type, `uima.tcas.Annotation`, is just one kind of definition of an `Annotation`. It was designed for annotating text strings, and has `begin` and `end` features which describe which substring of the Sofa being annotated.

For applications which have other kinds of Sofas, the UIMA developer will design their own kinds of `Annotation` types, as needed to describe an annotation, by declaring new types which are subtypes of `uima.cas.AnnotationBase`. For instance, for images, you might have the concept of a rectangular region to which the annotation applies. In this case, you might describe the region with 2 pairs of x, y coordinates.

5.5.2. Annotations have an associated Sofa

Annotations are always associated with a particular Sofa. In subsequent chapters, you will learn how there can be multiple Sofas associated with an artifact; which Sofa an annotation refers to is described by the Annotation feature structure itself.

All annotation types extend from the built-in type `uima.cas.AnnotationBase`. This type has one feature, a reference to the Sofa associated with the annotation. This value is currently used by the Framework to support the `getCoveredText()` method on the annotation instance - this returns the portion of a text Sofa that the annotation spans. It also is used to insure that the Annotation is indexed only in the CAS View associated with this Sofa.

5.6. AnnotationBase

A built-in type, `uima.cas.AnnotationBase`, is provided by UIMA to allow users to extend the Annotation capabilities to different kinds of Annotations. The `AnnotationBase` type has one feature, named `sofa`, which holds a reference to the `Sofa` feature structure with which this annotation is associated. The `sofa` feature is automatically set when creating an annotation (meaning — any type derived from the built-in `uima.cas.AnnotationBase` type); it should not be set by the user.

There is one method, `getView()`, provided by `AnnotationBase` that returns the CAS View for the Sofa the annotation is pointing at. Note that this method always returns a CAS, even when applied to JCas annotation instances.

The built-in type `uima.tcas.Annotation` extends `uima.cas.AnnotationBase` and adds two features, a `begin` and an `end` feature, which are suitable for identifying a span in a text string that the annotation applies to. Users may define other extensions to `AnnotationBase` with alternative specifications that can denote a particular region within the subject of analysis, as appropriate to their application.

Chapter 6. Multiple CAS Views of an Artifact

UIMA provides an extension to the basic model of the CAS which supports analysis of multiple views of the same artifact, all contained with the CAS. This chapter describes the concepts, terminology, and the API and XML extensions that enable this.

Multiple CAS Views can simplify things when different versions of the artifact are needed at different stages of the analysis. They are also key to enabling multimodal analysis where the initial artifact is transformed from one modality to another, or where the artifact itself is multimodal, such as the audio, video and closed-captioned text associated with an MPEG object. Each representation of the artifact can be analyzed independently with the standard UIMA programming model; in addition, multi-view components and applications can be constructed.

UIMA supports this by augmenting the CAS with additional light-weight CAS objects, one for each view, where these objects share most of the same underlying CAS, except for two things: each view has its own set of indexed Feature Structures, and each view has its own subject of analysis (Sofa) - its own version of the artifact being analyzed. The Feature Structure instances themselves are in the shared part of the CAS; only the entries in the indexes are unique for each CAS view.

All of these CAS view objects are kept together with the CAS, and passed as a unit between components in a UIMA application. APIs exist which allow components and applications to switch among the various view objects, as needed.

Feature Structures may be indexed in multiple views, if necessary. New methods on CAS Views facilitate adding or removing Feature Structures to or from their index repositories:

```
aView.addFsToIndexes(aFeatureStructure)
aView.removeFsFromIndexes(aFeatureStructure)
```

specify the view in which this Feature Structure should be added to or removed from the indexes.

6.1. CAS Views and Sofas

Sofas (see Section 5.1.2, “Subject of Analysis — Sofa”) and CAS Views are linked. In this implementation, every CAS view has one associated Sofa, and every Sofa has one associated CAS View.

6.1.1. Naming CAS Views and Sofas

The developer assigns a name to the View / Sofa, which is a simple string (following the rules for Java identifiers, usually without periods, but see special exception below). These names are declared in the component XML metadata, and are used during assembly and by the runtime to enable switching among multiple Views of the CAS at the same time.

Note: The name is called the Sofa name, for historical reasons, but it applies equally to the View. In the rest of this chapter, we'll refer to it as the Sofa name.

Some applications contain components that expect a variable number of Sofas as input or output. An example of a component that takes a variable number of input Sofas could be one that takes several translations of a document and merges them, where each translation was in a separate Sofa.

You can specify a variable number of input or output sofa names, where each name has the same base part, by writing the base part of the name (with no periods), followed by a period character

and an asterisk character (*). These denote sofas that have names matching the base part up to the period; for example, names such as `base_name_part.TTX_3d` would match a specification of `base_name_part.*`.

6.1.2. Multi-View, Single-View components & applications

Components and applications can be written to be Multi-View or Single-View. Most components used as primitive building blocks are expected to be Single-View. UIMA provides capabilities to combine these kinds of components with Multi-View components when assembling analysis aggregates or applications.

Single-View components and applications use only one subject of analysis, and one CAS View. The code and descriptors for these components do not use the facilities described in this chapter.

Conversely, Multi-View components and applications are aware of the possibility of multiple Views and Sofas, and have code and XML descriptors that create and manipulate them.

6.2. Multi-View Components

6.2.1. How UIMA decides if a component is Multi-View

Every UIMA component has an associated XML Component Descriptor. Multi-View components are identified simply as those whose descriptors declare one or more Sofa names in their Capability sections, as inputs or outputs. If a Component Descriptor does not mention any input or output Sofa names, the framework treats that component as a Single-View component.

A Multi-View component is passed a special kind of a CAS object, called a base CAS, which it must use to switch to the particular view it wishes to process. The base CAS object itself has no Sofa and no ability to use Indexes; only the views have that capability.

6.2.2. Multi-View: additional capabilities

Additional capabilities provided for components and applications aware of the possibilities of multiple Views and Sofas include:

- Creating new Views, and for each, setting up the associated Sofa data
- Getting a reference to an existing View and its associated Sofa, by name
- Specifying a view in which to index a particular Feature Structure instance

6.2.3. Component XML metadata

Each Multi-View component that creates a Sofa or wants to switch to a specific previously created Sofa must declare the name for the Sofa in the capabilities section. For example, a component expecting as input a web document in html format and creating a plain text document for further processing might declare:

```
<capabilities>
  <capability>
    <inputs/>
    <outputs/>
    <inputSofas>
      <sofaName>rawContent</sofaName>
    </inputSofas>
    <outputSofas>
      <sofaName>detagContent</sofaName>
    </outputSofas>
  </capability>
</capabilities>
```

```

</outputSofas>
</capability>
</capabilities>

```

Details on this specification are found in Chapter 2, *Component Descriptor Reference*. The Component Descriptor Editor supports Sofa declarations on the Section 1.9, “Capabilities Page”.

6.3. Sofa Capabilities and APIs for Applications

In addition to components, applications can make use of these capabilities. When an application creates a new CAS, it also creates the initial view of that CAS - and this view is the object that is returned from the create call. Additional views beyond this first one can be dynamically created at any time. The application can use the Sofa APIs described in Chapter 5, *Annotations, Artifacts, and Sofas* to specify the data to be analyzed.

If an Application creates a new CAS, the initial CAS that is created will be a view named “_InitialView”. This name can be used in the application and in Sofa Mapping (see the next section) to refer to this otherwise unnamed view.

6.4. Sofa Name Mapping

Sofa Name mapping is the mechanism which enables UIMA component developers to choose locally meaningful Sofa names in their source code and let aggregate, collection processing engine developers, and application developers connect output Sofas created in one component to input Sofas required in another.

At a given aggregation level, the assembler or application developer defines names for all the Sofas, and then specifies how these names map to the contained components, using the Sofa Map.

Consider annotator code to create a new CAS view:

```
CAS viewX = cas.createView("X");
```

Or code to get an existing CAS view:

```
CAS viewX = cas.getView("X");
```

Without Sofa name mapping the SofaID for the new Sofa will be “X”. However, if a name mapping for “X” has been specified by the aggregate or CPE calling this annotator, the actual SofaID in the CAS can be different.

All Sofas in a CAS must have unique names. This is accomplished by mapping all declared Sofas as described in the following sections. An attempt to create a Sofa with a SofaID already in use will throw an exception.

Sofa name mapping must not use the “.” (period) character. Runtime Sofa mapping maps names up to the “.” and appends the period and the following characters to the mapped name.

To get a Java Iterator for all the views in a CAS:

```
Iterator allViews = cas.getViewIterator();
```

To get a Java Iterator for selected views in a CAS, for example, views whose name is either exactly equal to namePrefix or is of the form namePrefix.suffix, where suffix can be any String:

```
Iterator someViews = cas.getViewIterator(String namePrefix);
```

Note: Sofa name mapping is applied to namePrefix.

Sofa name mappings are not currently supported for remote Analysis Engines. See [Section 6.4.5, “Name Mapping for Remote Services”](#) [112].

6.4.1. Name Mapping in an Aggregate Descriptor

For each component of an Aggregate, name mapping specifies the conversion between component Sofa names and names at the aggregate level.

Here's an example. Consider two Multi-View annotators to be assembled into an aggregate which takes an audio segment consisting of spoken English and produces a German text translation.

The first annotator takes an audio segment as input Sofa and produces a text transcript as output Sofa. The annotator designer might choose these Sofa names to be “AudioInput” and “TranscribedText”.

The second annotator is designed to translate text from English to German. This developer might choose the input and output Sofa names to be “EnglishDocument” and “GermanDocument”, respectively.

In order to hook these two annotators together, the following section would be added to the top level of the aggregate descriptor:

```
<sofaMappings>
  <sofaMapping>
    <componentKey>SpeechToText</componentKey>
    <componentSofaName>AudioInput</componentSofaName>
    <aggregateSofaName>SegmentedAudio</aggregateSofaName>
  </sofaMapping>
  <sofaMapping>
    <componentKey>SpeechToText</componentKey>
    <componentSofaName>TranscribedText</componentSofaName>
    <aggregateSofaName>EnglishTranscript</aggregateSofaName>
  </sofaMapping>
  <sofaMapping>
    <componentKey>EnglishToGermanTranslator</componentKey>
    <componentSofaName>EnglishDocument</componentSofaName>
    <aggregateSofaName>EnglishTranscript</aggregateSofaName>
  </sofaMapping>
  <sofaMapping>
    <componentKey>EnglishToGermanTranslator</componentKey>
    <componentSofaName>GermanDocument</componentSofaName>
    <aggregateSofaName>GermanTranslation</aggregateSofaName>
  </sofaMapping>
</sofaMappings>
```

The Component Descriptor Editor supports Sofa name mapping in aggregates and simplifies the task. See [Section 1.9.1, “Sofa \(and view\) name mappings”](#) for details.

6.4.2. Name Mapping in a CPE Descriptor

The CPE descriptor aggregates together a Collection Reader and CAS Processors (Annotators and CAS Consumers). Sofa mappings can be added to the following elements of CPE descriptors: <collectionIterator>, <casInitializer> and the <casProcessor>. To be consistent

with the organization of CPE descriptors, the maps for the CPE descriptor are distributed among the XML markup for each of the parts (`collectionIterator`, `casInitializer`, `casProcessor`). Because of this the `<componentKey>` element is not needed. Finally, rather than sub-elements for the parts, the XML markup for these uses attributes. See Section 3.6.1.3, “`<sofaNameMappings>` Element”.

Here's an example. Let's use the aggregate from the previous section in a collection processing engine. Here we will add a Collection Reader that outputs audio segments in an output Sofa named “nextSegment”. Remember to declare an output Sofa `nextSegment` in the collection reader description. We'll add a CAS Consumer in the next section.

```
<collectionReader>
  <collectionIterator>
    <descriptor>
      . . .
    </descriptor>
    <configurationParameterSettings>...</configurationParameterSettings>
    <sofaNameMappings>
      <sofaNameMapping componentSofaName="nextSegment"
                       cpeSofaName="SegementedAudio"/>
    </sofaNameMappings>
  </collectionIterator>
  <casInitializer/>
</collectionReader>
```

At this point the CAS Processor section for the aggregate does not need any Sofa mapping because the aggregate input Sofa has the same name, “SegementedAudio”, as is being produced by the Collection Reader.

6.4.3. Specifying the CAS View for a Single-View Component

Single-View components receive a Sofa named “_InitialView”, or a Sofa that is mapped to this name.

For example, assume that the CAS Consumer to be used in our CPE is a Single-View component that expects the analysis results associated with the input CAS, and that we want it to use the results from the translated German text Sofa. The following mapping added to the CAS Processor section for the CPE will instruct the CPE to get the CAS view for the German text Sofa and pass it to the CAS Consumer:

```
<casProcessor>
  . . .
  <sofaNameMappings>
    <sofaNameMapping componentSofaName="_InitialView"
                     cpeSofaName="GermanTranslation"/>
  </sofaNameMappings>
</casProcessor>
```

An alternative syntax for this kind of mapping is to simply leave out the component sofa name in this case.

6.4.4. Name Mapping in a UIMA Application

Applications which instantiate UIMA components directly using the `UIMAFramework` methods can also create a top level Sofa mapping using the “additional parameters” capability.

```
//create a "root" UIMA context for your whole application

UimaContextAdmin rootContext =
    UIMAFramework.newUimaContext(UIMAFramework.getLogger(),
        UIMAFramework.newDefaultResourceManager(),
        UIMAFramework.newConfigurationManager());

input = new XMLInputSource("test.xml");
desc = UIMAFramework.getXMLParser().parseAnalysisEngineDescription(input);

//setup sofa name mappings using the api

HashMap sofamappings = new HashMap();
sofamappings.put("localName1", "globalName1");
sofamappings.put("localName2", "globalName2");

//create a UIMA Context for the new AE we are about to create

//first argument is unique key among all AEs used in the application
UimaContextAdmin childContext = rootContext.createChild("myAE", sofamap);

//instantiate AE, passing the UIMA Context through the additional
//parameters map

Map additionalParams = new HashMap();
additionalParams.put(Resource.PARAM_UIMA_CONTEXT, childContext);

AnalysisEngine ae =
    UIMAFramework.produceAnalysisEngine(desc, additionalParams);
```

Sofa mappings are applied from the inside out, i.e., local to global. First, any aggregate mappings are applied, then any CPE mappings, and finally, any specified using this “additional parameters” capability.

6.4.5. Name Mapping for Remote Services

Currently, no client-side Sofa mapping information is passed from a UIMA client to a remote service. This can cause complications for UIMA services in a Multi-View application.

Remote Multi-View services will work only if the service is Single-View, or if the Sofa names expected by the service exactly match the Sofa names produced by the client.

If your application requires Sofa mappings for a remote Analysis Engine, you can wrap your remotely deployed AE in an aggregate (on the remote side), and specify the necessary Sofa mappings in the descriptor for that aggregate.

6.5. JCas extensions for Multiple Views

The JCas interface to the CAS can be used with any / all views, as well as the base CAS sent to Multi-View components. You can always get a JCas object from an existing CAS object by using the method `getJCas()`; this call will create the JCas if it doesn't already exist. If it does exist, it just returns the existing JCas that corresponds to the CAS.

JCas implements the `getView(...)` method, enabling switching to other named views, just like the corresponding method on the CAS. The JCas version, however, returns JCas objects, instead of CAS objects, corresponding to the view.

6.6. Sample Multi-View Application

The UIMA SDK contains a simple Sofa example application which demonstrates many Sofa specific concepts and methods. The source code for the application driver is in `examples/src/org/apache/uima/examples/SofaExampleApplication.java` and the Multi-View annotator is given in `SofaExampleAnnotator.java` in the same directory.

This sample application demonstrates a language translator annotator which expects an input text Sofa with an English document and creates an output text Sofa containing a German translation. Some of the key Sofa concepts illustrated here include:

- Sofa creation.
- Access of multiple CAS views.
- Unique feature structure index space for each view.
- Feature structures containing cross references between annotations in different CAS views.
- The strong affinity of annotations with a specific Sofa.

6.6.1. Annotator Descriptor

The annotator descriptor in `examples/descriptors/analysis_engine/SofaExampleAnnotator.xml` declares an input Sofa named “EnglishDocument” and an output Sofa named “GermanDocument”. A custom type “CrossAnnotation” is also defined:

```
<typeDescription>
  <name>sofa.test.CrossAnnotation</name>
  <description/>
  <supertypeName>uima.tcas.Annotation</supertypeName>
  <features>
    <featureDescription>
      <name>otherAnnotation</name>
      <description/>
      <rangeTypeName>uima.tcas.Annotation</rangeTypeName>
    </featureDescription>
  </features>
</typeDescription>
```

The `CrossAnnotation` type is derived from `uima.tcas.Annotation` and includes one new feature: a reference to another annotation.

6.6.2. Application Setup

The application driver instantiates an analysis engine, `seAnnotator`, from the annotator descriptor, obtains a new base CAS using that engine's CAS definition, and creates the expected input Sofa using:

```
CAS cas = seAnnotator.newCAS();
CAS aView = cas.createView("EnglishDocument");
```

Since `seAnnotator` is a primitive component, and no Sofa mapping has been defined, the `SofaID` will be “EnglishDocument”. Local Sofa data is set using:

```
aView.setDocumentText("this beer is good");
```

At this point the CAS contains all necessary inputs for the translation annotator and its process method is called.

6.6.3. Annotator Processing

Annotator processing consists of parsing the English document into individual words, doing word-by-word translation and concatenating the translations into a German translation. Analysis metadata on the English Sofa will be an annotation for each English word. Analysis metadata on the German Sofa will be a `CrossAnnotation` for each German word, where the `otherAnnotation` feature will be a reference to the associated English annotation.

Code of interest includes two CAS views:

```
// get View of the English text Sofa
englishView = aCas.getView("EnglishDocument");

// Create the output German text Sofa
germanView = aCas.createView("GermanDocument");
```

the indexing of annotations with the appropriate view:

```
englishView.addFsToIndexes(engAnnot);
. . .
germanView.addFsToIndexes(germAnnot);
```

and the combining of metadata belonging to different Sofas in the same feature structure:

```
// add link to English text
germAnnot.setFeatureValue(other, engAnnot);
```

6.6.4. Accessing the results of analysis

The application needs to get the results of analysis, which may be in different views. Analysis results for each Sofa are dumped independently by iterating over all annotations for each associated CAS view. For the English Sofa:

```
//get annotation iterator for this CAS
FSIndex anIndex = aView.getAnnotationIndex();
FSIterator anIter = anIndex.iterator();
while (anIter.isValid()) {
    AnnotationFS annot = (AnnotationFS) anIter.get();
    System.out.println(" " + annot.getType().getName()
        + ": " + annot.getCoveredText());
    anIter.moveToNext();
}
```

Iterating over all German annotations looks the same, except for the following:

```
if (annot.getType() == cross) {
    AnnotationFS crossAnnot =
        (AnnotationFS) annot.getFeatureValue(other);
    System.out.println("    other annotation feature: "
        + crossAnnot.getCoveredText());
}
```

Of particular interest here is the built-in Annotation type method `getCoveredText()`. This method uses the “begin” and “end” features of the annotation to create a substring from the CAS

document. The SofaRef feature of the annotation is used to identify the correct Sofa's data from which to create the substring.

The example program output is:

```
---Printing all annotations for English Sofa---
uima.tcas.DocumentAnnotation: this beer is good
uima.tcas.Annotation: this
uima.tcas.Annotation: beer
uima.tcas.Annotation: is
uima.tcas.Annotation: good

---Printing all annotations for German Sofa---
uima.tcas.DocumentAnnotation: das bier ist gut
sofa.test.CrossAnnotation: das
  other annotation feature: this
sofa.test.CrossAnnotation: bier
  other annotation feature: beer
sofa.test.CrossAnnotation: ist
  other annotation feature: is
sofa.test.CrossAnnotation: gut
  other annotation feature: good
```

6.7. Views API Summary

The recommended way to deliver a particular CAS view to a *Single-View* component is to use by Sofa-mapping in the CPE and/or aggregate descriptors.

For *Multi-View* components or applications, the following methods are used to create or get a reference to a CAS view for a particular Sofa:

Creating a new View:

```
JCas newView = aJCas.createView(String localNameOfTheViewBeforeMapping);
CAS  newView = aCAS .createView(String localNameOfTheViewBeforeMapping);
```

Getting a View from a CAS or JCas:

```
JCas myView = aJCas.getView(String localNameOfTheViewBeforeMapping);
CAS  myView = aCAS .getView(String localNameOfTheViewBeforeMapping);
Iterator allViews = aCasOrJCas.getViewIterator();
Iterator someViews = aCasOrJCas.getViewIterator(String localViewNamePrefix);
```

The following methods are useful for all annotators and applications:

Setting Sofa data for a CAS or JCas:

```
aCasOrJCas.setDocumentText(String docText);
aCasOrJCas.setSofaDataString(String docText, String mimeType);
aCasOrJCas.setSofaDataArray(FeatureStructure array, String mimeType);
aCasOrJCas.setSofaDataURI(String uri, String mimeType);
```

Getting Sofa data for a particular CAS or JCas:

```
String doc = aCasOrJCas.getDocumentText();
String doc = aCasOrJCas.getSofaDataString();
FeatureStructure array = aCasOrJCas.getSofaDataArray();
```

```
String uri = aCasOrJCas.getSofaDataURI();
InputStream is = aCasOrJCas.getSofaDataStream();
```

6.8. Sofa Incompatibilities between UIMA version 1 and version 2

A major change in version 2 is related to the support of Single-View components and applications. Given an analysis engine, *ae*, the API

```
CAS cas = ae.newCas();
```

used to return the base CAS. Now it returns a view of the Sofa named “_InitialView”. This Sofa will actually only be created if any Sofa data is set for this view. The initial view is used for Single-View applications and Multi-View annotators with no Sofa mapping.

The process method of Multi-View annotators receive the base CAS, however the base CAS no longer has an index repository to hold “global” data. Global data needs to be put in a specific named CAS view of your choice.

Because of these changes, the following scenarios will break with v2.0 clients:

- Any version 1.x services (you must migrate the services to version 2).
- Applications or components explicitly referencing “_DefaultTextSofaName” in code or descriptors.
- Multi-View applications using the Base CAS index repository.

Chapter 7. CAS Multiplier Developer's Guide

The UIMA analysis components (Annotators and CAS Consumers) described previously in this manual all take a single CAS as input, optionally make modifications to it, and output that same CAS. This chapter describes an advanced feature that became available in the UIMA SDK v2.0: a new type of analysis component called a *CAS Multiplier*, which can create new CASes during processing.

CAS Multipliers are often used to split a large artifact into manageable pieces. This is a common requirement of audio and video analysis applications, but can also occur in text analysis on very large documents. A CAS Multiplier would take as input a single CAS representing the large artifact (perhaps by a remote reference to the actual data — see Section 5.2, “Formats of Sofa Data”) and produce as output a series of new CASes each of which contains only a small portion of the original artifact.

CAS Multipliers are not limited to dividing an artifact into smaller pieces, however. A CAS Multiplier can also be used to combine smaller segments together to form larger segments. In general, a CAS Multiplier is used to *change* the segmentation of a series of CASes; that is, to change how a stream of data is divided among discrete CAS objects.

7.1. Developing the CAS Multiplier Code

7.1.1. CAS Multiplier Interface Overview

CAS Multiplier implementations should extend from the `JCasMultiplier_ImplBase` or `CasMultiplier_ImplBase` classes, depending on which CAS interface they prefer to use. As with other types of analysis components, the CAS Multiplier ImplBase classes define optional `initialize`, `destroy`, and `reconfigure` methods. There are then three required methods: `process`, `hasNext`, and `next`. The framework interacts with these methods as follows:

1. The framework calls the CAS Multiplier's `process` method, passing it an input CAS. The `process` method returns, but may hold on to a reference to the input CAS.
2. The framework then calls the CAS Multiplier's `hasNext` method. The CAS Multiplier should return `true` from this method if it intends to output one or more new CASes (for instance, segments of this CAS), and `false` if not.
3. If `hasNext` returned `true`, the framework will call the CAS Multiplier's `next` method. The CAS Multiplier creates a new CAS (we will see how in a moment), populates it, and returns it from the `next` method.
4. Steps 2 and 3 continue until `hasNext` returns `false`. If the framework detects a situation where it needs to cancel this CAS Multiplier, it will stop calling the `hasNext` and `next` methods, and when another top-level CAS comes along it will call the annotator's `process` method again. User's annotator code should interpret this as a signal to cleanup processing related to the previous CAS and then start processing with the new CAS.

From the time when `process` is called until the `hasNext` method returns `false` (or `process` is called again), the CAS Multiplier “owns” the CAS that was passed to its `process` method. The CAS Multiplier can store a reference to this CAS in a local field and can read from it or write to it during this time. Once the ending condition occurs, the CAS Multiplier gives up ownership of the input CAS and should no longer retain a reference to it.

7.1.2. How to Get an Empty CAS Instance

The CAS Multiplier's `next` method must return a CAS instance that represents a new representation of the input artifact. Since CAS instances are managed by the framework, the CAS Multiplier cannot actually create a new CAS; instead it should request an empty CAS by calling the method:

```
CAS getEmptyCAS()
or
JCas getEmptyJCas()
```

which are defined on the `CasMultiplier_ImplBase` and `JCasMultiplier_ImplBase` classes, respectively.

Note that if it is more convenient you can request an empty CAS during the `process` or `hasNext` methods, not just during the `next` method.

By default, a CAS Multiplier is only allowed to hold one output CAS instance at a time. You must return the CAS from the `next` method before you can request a second CAS. If you try to call `getEmptyCAS` a second time you will get an Exception. You can change this default behavior by overriding the method `getCasInstancesRequired` to return the number of CAS instances that you need. Be aware that CAS instances consume a significant amount of memory, so setting this to a large value will cause your application to use a lot of RAM. So, for example, it is not a good practice to attempt to generate a large number of new CASes in the CAS Multiplier's `process` method. Instead, you should spread your processing out across the calls to the `hasNext` or `next` methods.

Note: You can only call `getEmptyCAS()` or `getEmptyJCas()` from your CAS Multiplier's `process`, `hasNext`, or `next` methods. You cannot call it from other methods such as `initialize`. This is because the Aggregate AE's Type System is not available until all of the components of the aggregate have finished their initialization.

The Type System of the empty CAS will contain all of the type definitions for all components of the outermost Aggregate Analysis Engine or Collection Processing Engine that contains your CAS Multiplier. Therefore downstream components that receive these CASes can add new instances of any type that they define.

Warning: Be careful to keep the Feature Structures that belong to each CAS separate. You cannot create references from a Feature Structure in one CAS to a Feature Structure in another CAS. You also cannot add a Feature Structure created in one CAS to the indexes of a different CAS. If you attempt to do this, the results are undefined.

7.1.3. Example Code

This section walks through the source code of an example CAS Multiplier that breaks text documents into smaller pieces. The Java class for the example is `org.apache.uima.examples.casMultiplier.SimpleTextSegmenter` and the source code is included in the UIMA SDK under the `examples/src` directory.

7.1.3.1. Overall Structure

```
public class SimpleTextSegmenter extends JCasMultiplier_ImplBase {
    private String mDoc;
```

```

private int mPos;
private int mSegmentSize;
private String mDocUri;

public void initialize(UimaContext aContext)
    throws ResourceInitializationException
{ ... }

public void process(JCas aJCas) throws AnalysisEngineProcessException
{ ... }

public boolean hasNext() throws AnalysisEngineProcessException
{ ... }

public AbstractCas next() throws AnalysisEngineProcessException
{ ... }
}

```

The `SimpleTextSegmenter` class extends `JCasMultiplier_ImplBase` and implements the optional `initialize` method as well as the required `process`, `hasNext`, and `next` methods. Each method is described below.

7.1.3.2. Initialize Method

```

public void initialize(UimaContext aContext) throws
    ResourceInitializationException {
    super.initialize(aContext);
    mSegmentSize = ((Integer)aContext.getConfigParameterValue(
        "segmentSize")).intValue();
}

```

Like an Annotator, a CAS Multiplier can override the `initialize` method and read configuration parameter values from the `UimaContext`. The `SimpleTextSegmenter` defines one parameter, “Segment Size”, which determines the approximate size (in characters) of each segment that it will produce.

7.1.3.3. Process Method

```

public void process(JCas aJCas)
    throws AnalysisEngineProcessException {
    mDoc = aJCas.getDocumentText();
    mPos = 0;
    // retrieve the filename of the input file from the CAS so that it can
    // be added to each segment
    FSIterator it = aJCas.
        getAnnotationIndex(SourceDocumentInformation.type).iterator();
    if (it.hasNext()) {
        SourceDocumentInformation fileLoc =
            (SourceDocumentInformation)it.next();
        mDocUri = fileLoc.getUri();
    }
    else {
        mDocUri = null;
    }
}

```

The `process` method receives a new `JCas` to be processed (segmented) by this CAS Multiplier. The `SimpleTextSegmenter` extracts some information from this `JCas` and stores it in fields (the

document text is stored in the field `mDoc` and the source URI in the field `mDocURI`). Recall that the CAS Multiplier is considered to “own” the JCas from the time when `process` is called until the time when `hasNext` returns false. Therefore it is acceptable to retain references to objects from the JCas in a CAS Multiplier, whereas this should never be done in an Annotator. The CAS Multiplier could have chosen to store a reference to the JCas itself, but that was not necessary for this example.

The CAS Multiplier also initializes the `mPos` variable to 0. This variable is a position into the document text and will be incremented as each new segment is produced.

7.1.3.4. hasNext Method

```
public boolean hasNext() throws AnalysisEngineProcessException {
    return mPos < mDoc.length();
}
```

The job of the `hasNext` method is to report whether there are any additional output CASes to produce. For this example, the CAS Multiplier will break the entire input document into segments, so we know there will always be a next segment until the very end of the document has been reached.

7.1.3.5. Next Method

```
public AbstractCas next() throws AnalysisEngineProcessException {
    int breakAt = mPos + mSegmentSize;
    if (breakAt > mDoc.length())
        breakAt = mDoc.length();

    // search for the next newline character.
    // Note: this example segmenter implementation
    // assumes that the document contains many newlines.
    // In the worst case, if this segmenter
    // is run on a document with no newlines,
    // it will produce only one segment containing the
    // entire document text.
    // A better implementation might specify a maximum segment size as
    // well as a minimum.

    while (breakAt < mDoc.length() &&
           mDoc.charAt(breakAt - 1) != '\n')
        breakAt++;

    JCas jcas = getEmptyJCas();
    try {
        jcas.setDocumentText(mDoc.substring(mPos, breakAt));
        // if original CAS had SourceDocumentInformation,
        // also add SourceDocumentInformation
        // to each segment
        if (mDocUri != null) {
            SourceDocumentInformation sdi =
                new SourceDocumentInformation(jcas);
            sdi.setUri(mDocUri);
            sdi.setOffsetInSource(mPos);
            sdi.setDocumentSize(breakAt - mPos);
            sdi.addToIndexes();

            if (breakAt == mDoc.length()) {
                sdi.setLastSegment(true);
            }
        }
    }
}
```

```
    }  
  }  
  
  mPos = breakAt;  
  return jcas;  
} catch (Exception e) {  
  jcas.release();  
  throw new AnalysisEngineProcessException(e);  
}  
}
```

The next method actually produces the next segment and returns it. The framework guarantees that it will not call `next` unless `hasNext` has returned true since the last call to `process` or `next`.

Note that in order to produce a segment, the CAS Multiplier must get an empty JCas to populate. This is done by the line:

```
JCas jcas = getEmptyJCas();
```

This requests an empty JCas from the framework, which maintains a pool of JCas instances to draw from.

Also, note the use of the `try...catch` block to ensure that a JCas is released back to the pool if an exception occurs. This is very important to allow a CAS Multiplier to recover from errors.

7.2. Creating the CAS Multiplier Descriptor

There is not a separate type of descriptor for a CAS Multiplier. CAS Multiplier are considered a type of Analysis Engine, and so their descriptors use the same syntax as any other Analysis Engine Descriptor.

The descriptor for the `SimpleTextSegmenter` is located in the `examples/descriptors/cas_multiplier/SimpleTextSegmenter.xml` directory of the UIMA SDK.

The Analysis Engine Description, in its “Operational Properties” section, now contains a new “`outputsNewCASes`” property which takes a Boolean value. If the Analysis Engine is a CAS Multiplier, this property should be set to true.

If you use the CDE, be sure to check the “Outputs new CASes” box in the Runtime Information section on the Overview page, as shown here:

SimpleTextSegmenter.xml

Overview

▼ **Implementation Details**

Implementation Language C/C++ Java

Engine Type Primitive Aggregate

▼ **Runtime Information**

This section describes information about how to run this component

updates the CAS

multiple deployment allowed

Outputs new CASes

Name of the Java class file

If you edit the Analysis Engine Descriptor by hand, you need to add a `<outputsNewCASes>` element to your descriptor as shown here:

```
<operationalProperties>
  <modifiesCas>false</modifiesCas>
  <multipleDeploymentAllowed>true</multipleDeploymentAllowed>
  <outputsNewCASes>true</outputsNewCASes>
</operationalProperties>
```

Note: The “modifiedCas” operational property refers to the input CAS, not the new output CASes produced. So our example SimpleTextSegmenter has modifiesCas set to false since it doesn't modify the input CAS.

7.3. Using a CAS Multiplier in an Aggregate Analysis Engine

You can include a CAS Multiplier as a component in an Aggregate Analysis Engine. For example, this allows you to construct an Aggregate Analysis Engine that takes each input CAS, breaks it up into segments, and runs a series of Annotators on each segment.

7.3.1. Adding the CAS Multiplier to the Aggregate

Since CAS Multiplier are considered a type of Analysis Engine, adding them to an aggregate works the same way as for other Analysis Engines. Using the CDE, you just click the “Add...” button in the Component Engines view and browse to the Analysis Engine Descriptor of your CAS Multiplier. If editing the aggregate descriptor directly, just `import` the Analysis Engine Descriptor of your CAS Multiplier as usual.

An example descriptor for an Aggregate Analysis Engine containing a CAS Multiplier is provided in `examples/descriptors/cas_multiplier/SegmenterAndTokenizerAE.xml`. This Aggregate runs the SimpleTextSegmenter example to break a large document into segments, and then runs each segment through the SimpleTokenAndSentenceAnnotator. Try running it

in the Document Analyzer tool with a large text file as input, to see that it outputs multiple output CASes, one for each segment produced by the `SimpleTextSegmenter`.

7.3.2. CAS Multipliers and Flow Control

CAS Multipliers are only supported in the context of Fixed Flow or custom Flow Control. If you use the built-in “Fixed Flow” for your Aggregate Analysis Engine, you can position the CAS Multiplier anywhere in that flow. Processing then works as follows: When a CAS is input to the Aggregate AE, that CAS is routed to the components in the order specified by the Fixed Flow, until that CAS reaches a CAS Multiplier.

Upon reaching a CAS Multiplier, if that CAS Multiplier produces new output CASes, then each output CAS from that CAS Multiplier will continue through the flow, starting at the node immediately after the CAS Multiplier in the Fixed Flow. No further processing will be done on the original input CAS after it has reached a CAS Multiplier – it will *not* continue in the flow.

If the CAS Multiplier does *not* produce any output CASes for a given input CAS, then that input CAS *will* continue in the flow. This behavior is appropriate, for example, for a CAS Multiplier that may segment an input CAS into pieces but only does so if the input CAS is larger than a certain size.

It is possible to put more than one CAS Multiplier in your flow. In this case, when a new CAS output from the first CAS Multiplier reaches the second CAS Multiplier and if the second CAS Multiplier produces output CASes, then no further processing will occur on the input CAS, and any new output CASes produced by the second CAS Multiplier will continue the flow starting at the node after the second CAS Multiplier.

This default behavior can be customized. The `FixedFlowController` component that implements UIMA's default flow defines a configuration parameter `ActionAfterCasMultiplier` that can take the following values:

- `continue` – the CAS continues on to the next element in the flow
- `stop` – the CAS will no longer continue in the flow, and will be returned from the aggregate if possible.
- `drop` – the CAS will no longer continue in the flow, and will be dropped (not returned from the aggregate) if possible.
- `dropIfNewCasProduced` (the default) – if the CAS multiplier produced a new CAS as a result of processing this CAS, then this CAS will be dropped. If not, then this CAS will continue.

You can override this parameter in your Aggregate Analysis Engine the same way you would override a parameter in a delegate Analysis Engine. But to do so you must first explicitly identify that you are using the `FixedFlowController` implementation by importing its descriptor into your aggregate as follows:

```
<flowController key="FixedFlowController">
  <import name="org.apache.uima.flow.FixedFlowController" />
</flowController>
```

The parameter could then be overridden as, for example:

```

<configurationParameters>
  <configurationParameter>
    <name>ActionForIntermediateSegments</name>
    <type>String</type>
    <multiValued>>false</multiValued>
    <mandatory>>false</mandatory>
    <overrides>
      <parameter>
        FixedFlowController/ActionAfterCasMultiplier
      </parameter>
    </overrides>
  </configurationParameter>
</configurationParameters>

<configurationParameterSettings>
  <nameValuePair>
    <name>ActionForIntermediateSegments</name>
    <value>
      <string>drop</string>
    </value>
  </nameValuePair>
</configurationParameterSettings>

```

This overriding can also be done using the Component Descriptor Editor tool. An example of an Analysis Engine that overrides this parameter can be found in `examples/descriptors/cas_multiplier/Segment_Annotate_Merge_AE.xml`. For more information about how to specify a flow controller as part of your Aggregate Analysis Engine descriptor, see Section 4.3, “Adding Flow Controller to an Aggregate”.

If you would like to further customize the flow, you will need to implement a custom FlowController as described in Chapter 4, *Flow Controller Developer's Guide*. For example, you could implement a flow where a CAS that is input to a CAS Multiplier will be processed further by *some* downstream components, but not others.

7.3.3. Aggregate CAS Multipliers

An important consideration when you put a CAS Multiplier inside an Aggregate Analysis Engine is whether you want the Aggregate to also function as a CAS Multiplier – that is, whether you want the new output CASes produced within the Aggregate to be output from the Aggregate. This is controlled by the `<outputsNewCASes>` element in the Operational Properties of your Aggregate Analysis Engine descriptor. The syntax is the same as what was described in Section 7.2, “CAS Multiplier Descriptor” [121].

If you set this property to `true`, then any new output CASes produced by a CAS Multiplier inside this Aggregate will be output from the Aggregate. Thus the Aggregate will function as a CAS Multiplier and can be used in any of the ways in which a primitive CAS Multiplier can be used.

If you set the `<outputsNewCASes>` property to `false`, then any new output CASes produced by a CAS Multiplier inside the Aggregate will be dropped (i.e. the CASes will be released back to the pool) once they have finished being processed. Such an Aggregate Analysis Engine functions just like a “normal” non-CAS-Multiplier Analysis Engine; the fact that CAS Multiplication is occurring inside it is hidden from users of that Analysis Engine.

Note: If you want to output some new Output CASes and not others, you need to implement a custom Flow Controller that makes this decision — see Section 4.5, “Using Flow Controllers with CAS Multipliers”.

7.4. Using a CAS Multiplier in a Collection Processing Engine

It is currently a limitation that CAS Multiplier cannot be deployed directly in a Collection Processing Engine. The only way that you can use a CAS Multiplier in a CPE is to first wrap it in an Aggregate Analysis Engine whose `outputsNewCASes` property is set to `false`, which in effect hides the existence of the CAS Multiplier from the CPE.

Note that you can build an Aggregate Analysis Engine that consists of CAS Multipliers and Annotators, followed by CAS Consumers. This can simulate what a CPE would do, but without the deployment and error handling options that the CPE provides.

7.5. Calling a CAS Multiplier from an Application

7.5.1. Retrieving Output CASes from the CAS Multiplier

The `AnalysisEngine` interface has the following methods that allow you to interact with CAS Multiplier:

- `CasIterator processAndOutputNewCASes(CAS)`
- `JCasIterator processAndOutputNewCASes(JCas)`

From your application, you call `processAndOutputNewCASes` and pass it the input CAS. An iterator is returned that allows you to step through each of the new output CASes that are produced by the Analysis Engine.

It is very important to realize that CASes are pooled objects and so your application must release each CAS (by calling the `CAS.release()` method) that it obtains from the `CasIterator` *before* it calls the `CasIterator.next` method again. Otherwise, the CAS pool will be exhausted and a deadlock will occur.

The example code in the class `org.apache.uima.examples.casMultiplier.CasMultiplierExampleApplication` illustrates this. Here is the main processing loop:

```
CasIterator casIterator = ae.processAndOutputNewCASes(initialCas);
while (casIterator.hasNext()) {
    CAS outCas = casIterator.next();

    //dump the document text and annotations for this segment
    System.out.println("***** NEW SEGMENT *****");
    System.out.println(outCas.getDocumentText());
    PrintAnnotations.printAnnotations(outCas, System.out);

    //release the CAS (important)
    outCas.release();
}
```

Note that as defined by the CAS Multiplier contract in [Section 7.1.1, “CAS Multiplier Interface Overview” \[117\]](#), the CAS Multiplier owns the input CAS (`initialCas` in the example) until the last new output CAS has been produced. This means that the application should not try to make changes to `initialCas` until after the `CasIterator.hasNext` method has returned `false`, indicating that the segmenter has finished.

Note that the processing time of the Analysis Engine is spread out over the calls to the `CasIterator`'s `hasNext` and `next` methods. That is, the next output CAS may not actually be produced and annotated until the application asks for it. So the application should not expect calls to the `CasIterator` to necessarily complete quickly.

Also, calls to the `CasIterator` may throw Exceptions indicating an error has occurred during processing. If an Exception is thrown, all processing of the input CAS will stop, and no more output CASes will be produced. There is currently no error recovery mechanism that will allow processing to continue after an exception.

7.5.2. Using a CAS Multiplier with other Analysis Engines

In your application you can take the output CASes from a CAS Multiplier and pass them to the `process` method of other Analysis Engines. However there are some special considerations regarding the Type System of these CASes.

By default, the output CASes of a CAS Multiplier will have a Type System that contains all of the types and features declared by any component in the outermost Aggregate Analysis Engine or Collection Processing Engine that contains the CAS Multiplier. If in your application you create a CAS Multiplier and another Analysis Engine, where these are not enclosed in an aggregate, then the output CASes from the CAS Multiplier will not support any types or features that are declared in the latter Analysis Engine but not in the CAS Multiplier.

This can be remedied by forcing the CAS Multiplier and Analysis Engine to share a single `UimaContext` when they are created, as follows:

```
//create a "root" UIMA context for your whole application

UimaContextAdmin rootContext =
    UIMAFramework.newUimaContext(UIMAFramework.getLogger(),
        UIMAFramework.newDefaultResourceManager(),
        UIMAFramework.newConfigurationManager());

XMLInputSource input = new XMLInputSource("MyCasMultiplier.xml");
AnalysisEngineDescription desc = UIMAFramework.getXMLParser().
    parseAnalysisEngineDescription(input);

//create a UIMA Context for the new AE we are about to create

//first argument is unique key among all AEs used in the application
UimaContextAdmin childContext = rootContext.createChild(
    "myCasMultiplier", Collections.EMPTY_MAP);

//instantiate CAS Multiplier AE, passing the UIMA Context through the
//additional parameters map

Map additionalParams = new HashMap();
additionalParams.put(Resource.PARAM_UIMA_CONTEXT, childContext);

AnalysisEngine casMultiplierAE = UIMAFramework.produceAnalysisEngine(
    desc,additionalParams);

//repeat for another AE
XMLInputSource input2 = new XMLInputSource("MyAE.xml");
AnalysisEngineDescription desc2 = UIMAFramework.getXMLParser().
    parseAnalysisEngineDescription(input2);

UimaContextAdmin childContext2 = rootContext.createChild(
```

```
"myAE", Collections.EMPTY_MAP);

Map additionalParams2 = new HashMap();
additionalParams2.put(Resource.PARAM_UIMA_CONTEXT, childContext2);

AnalysisEngine myAE = UIMAFramework.produceAnalysisEngine(
    desc2, additionalParams2);
```

7.6. Using a CAS Multiplier to Merge CASes

A CAS Multiplier can also be used to combine smaller CASes together to form larger CASes. In this section we describe how this works and walk through an example.

7.6.1. Overview of How to Merge CASes

1. When the framework first calls the CAS Multiplier's `process` method, the CAS Multiplier requests an empty CAS (which we'll call the "merged CAS") and copies relevant data from the input CAS into the merged CAS. The class `org.apache.uima.util.CasCopier` provides utilities for copying Feature Structures between CASes.
2. When the framework then calls the CAS Multiplier's `hasNext` method, the CAS Multiplier returns `false` to indicate that it has no output at this time.
3. When the framework calls `process` again with a new input CAS, the CAS Multiplier copies data from that input CAS into the merged CAS, combining it with the data that was previously copied.
4. Eventually, when the CAS Multiplier decides that it wants to output the merged CAS, it returns `true` from the `hasNext` method, and then when the framework subsequently calls the `next` method, the CAS Multiplier returns the merged CAS.

Note: There is no explicit call to flush out any pending CASes from a CAS Multiplier when collection processing completes. It is up to the application to provide some mechanism to let a CAS Multiplier recognize the last CAS in a collection so that it can ensure that its final output CASes are complete.

7.6.2. Example CAS Merger

An example CAS Multiplier that merges CASes can be found is provided in the UIMA SDK. The Java class for this example is `org.apache.uima.examples.casMultiplier.SimpleTextMerger` and the source code is located under the `examples/src` directory.

7.6.2.1. Process Method

Almost all of the code for this example is in the `process` method. The first part of the `process` method shows how to copy Feature Structures from the input CAS to the "merged CAS":

```
public void process(JCas aJCas) throws AnalysisEngineProcessException {
    // procure a new CAS if we don't have one already
    if (mMergedCas == null) {
        mMergedCas = getEmptyJCas();
    }

    // append document text
```

```

String docText = aJCas.getDocumentText();
int prevDocLen = mDocBuf.length();
mDocBuf.append(docText);

// copy specified annotation types
// CasCopier takes two args: the CAS to copy from.
//                               the CAS to copy into.
CasCopier copier = new CasCopier(aJCas.getCas(), mMergedCas.getCas());

// needed in case one annotation is in two indexes (could
// happen if specified annotation types overlap)
Set copiedIndexedFs = new HashSet();
for (int i = 0; i < mAnnotationTypesToCopy.length; i++) {
    Type type = mMergedCas.getTypeSystem()
        .getType(mAnnotationTypesToCopy[i]);
    FSIndex index = aJCas.getCas().getAnnotationIndex(type);
    Iterator iter = index.iterator();
    while (iter.hasNext()) {
        FeatureStructure fs = (FeatureStructure) iter.next();
        if (!copiedIndexedFs.contains(fs)) {
            Annotation copyOfFs = (Annotation) copier.copyFs(fs);
            // update begin and end
            copyOfFs.setBegin(copyOfFs.getBegin() + prevDocLen);
            copyOfFs.setEnd(copyOfFs.getEnd() + prevDocLen);
            mMergedCas.addFsToIndexes(copyOfFs);
            copiedIndexedFs.add(fs);
        }
    }
}

```

The `CasCopier` class is used to copy Feature Structures of certain types (specified by a configuration parameter) to the merged CAS. The `CasCopier` does deep copies, meaning that if the copied `FeatureStructure` references another `FeatureStructure`, the referenced `FeatureStructure` will also be copied.

This example also merges the document text using a separate `StringBuffer`. Note that we cannot append document text to the Sofa data of the merged CAS because Sofa data cannot be modified once it is set.

The remainder of the `process` method determines whether it is time to output a new CAS. For this example, we are attempting to merge all CASes that are segments of one original artifact. This is done by checking the `SourceDocumentInformation` Feature Structure in the CAS to see if its `lastSegment` feature is set to `true`. That feature (which is set by the example `SimpleTextSegmenter` discussed previously) marks the CAS as being the last segment of an artifact, so when the CAS Multiplier sees this segment it knows it is time to produce an output CAS.

```

// get the SourceDocumentInformation FS,
// which indicates the sourceURI of the document
// and whether the incoming CAS is the last segment
FSIterator it = aJCas
    .getAnnotationIndex(SourceDocumentInformation.type).iterator();
if (!it.hasNext()) {
    throw new RuntimeException("Missing SourceDocumentInformation");
}
SourceDocumentInformation sourceDocInfo =
    (SourceDocumentInformation) it.next();
if (sourceDocInfo.getLastSegment()) {
    // time to produce an output CAS
    // set the document text

```

```
mMergedCas.setDocumentText(mDocBuf.toString());

// add source document info to destination CAS
SourceDocumentInformation destSDI =
    new SourceDocumentInformation(mMergedCas);
destSDI.setUri(sourceDocInfo.getUri());
destSDI.setOffsetInSource(0);
destSDI.setLastSegment(true);
destSDI.addToIndexes();

mDocBuf = new StringBuffer();
mReadyToOutput = true;
}
```

When it is time to produce an output CAS, the CAS Multiplier makes final updates to the merged CAS (setting the document text and adding a `SourceDocumentInformation` `FeatureStructure`), and then sets the `mReadyToOutput` field to true. This field is then used in the `hasNext` and `next` methods.

7.6.2.2. hasNext and next Methods

These methods are relatively simple:

```
public boolean hasNext() throws AnalysisEngineProcessException {
    return mReadyToOutput;
}

public AbstractCas next() throws AnalysisEngineProcessException {
    if (!mReadyToOutput) {
        throw new RuntimeException("No next CAS");
    }
    JCas casToReturn = mMergedCas;
    mMergedCas = null;
    mReadyToOutput = false;
    return casToReturn;
}
```

When the merged CAS is ready to be output, `hasNext` will return true, and `next` will return the merged CAS, taking care to set the `mMergedCas` field to null so that the next call to `process` will start with a fresh CAS.

7.6.3. Using the SimpleTextMerger in an Aggregate Analysis Engine

An example descriptor for an Aggregate Analysis Engine that uses the `SimpleTextMerger` is provided in `examples/descriptors/cas_multiplier/Segment_Annotate_Merge_AE.xml`. This Aggregate first runs the `SimpleTextSegmenter` example to break a large document into segments. It then runs each segment through the example tokenizer and name recognizer annotators. Finally it runs the `SimpleTextMerger` to reassemble the segments back into one CAS. The `Name` annotations are copied to the final merged CAS but the `Token` annotations are not.

This example illustrates how you can break large artifacts into pieces for more efficient processing and then reassemble a single output CAS containing only the results most useful to the application. Intermediate results such as tokens, which may consume a lot of space, need not be retained over the entire input artifact.

The intermediate segments are dropped and are never output from the Aggregate Analysis Engine. This is done by configuring the Fixed Flow Controller as described in [Section 7.3.2, “CAS Multipliers and Flow Control” \[123\]](#), above.

Try running this Analysis Engine in the Document Analyzer tool with a large text file as input, to see that it outputs just one CAS per input file, and that the final CAS contains only the Name annotations.

Chapter 8. XMI and EMF Interoperability

8.1. Overview

In traditional object-oriented terms, a UIMA Type System is a class model and a UIMA CAS is an object graph. There are established standards in this area – specifically, UML® is an OMG™ standard for class models and XMI (XML Metadata Interchange) is an OMG standard for the XML representation of object graphs.

Furthermore, the Eclipse Modeling Framework (EMF) is an open-source framework for model-based application development, and it is based on UML and XMI. In EMF, you define class models using a metamodel called Ecore, which is similar to UML. EMF provides tools for converting a UML model to Ecore. EMF can then generate Java classes from your model, and supports persistence of those classes in the XMI format.

The UIMA SDK provides tools for interoperability with XMI and EMF. These tools allow conversions of UIMA Type Systems to and from Ecore models, as well as conversions of UIMA CASes to and from XMI format. This provides a number of advantages, including:

You can define a model using a UML Editor, such as Rational Rose or EclipseUML, and then automatically convert it to a UIMA Type System.

You can take an existing UIMA application, convert its type system to Ecore, and save the CASes it produces to XMI. This data is now in a form where it can easily be ingested by an EMF-based application.

More generally, we are adopting the well-documented, open standard XMI as the standard way to represent UIMA-compliant analysis results (replacing the UIMA-specific XCAS format). This use of an open standard enables other applications to more easily produce or consume these UIMA analysis results.

For more information on XMI, see Grose et al. *Mastering XMI. Java Programming with XMI, XML, and UML*. John Wiley & Sons, Inc. 2002.

For more information on EMF, see Budinsky et al. *Eclipse Modeling Framework 2.0*. Addison-Wesley. 2006.

For details of how the UIMA CAS is represented in XMI format, see Chapter 7, *XMI CAS Serialization Reference*.

8.2. Converting an Ecore Model to or from a UIMA Type System

The UIMA SDK provides the following two classes:

Ecore2UimaTypeSystem: converts from an .ecore model developed using EMF to a UIMA-compliant TypeSystem descriptor. This is a Java class that can be run as a standalone program or invoked from another Java application. To run as a standalone program, execute:

```
java org.apache.uima.ecore.Ecore2UimaTypeSystem <ecore file> <output file>
```

The input .ecore file will be converted to a UIMA TypeSystem descriptor and written to the specified output file. You can then use the resulting TypeSystem descriptor in your UIMA application.

UimaTypeSystem2Ecore: converts from a UIMA TypeSystem descriptor to an .ecore model. This is a Java class that can be run as a standalone program or invoked from another Java application. To run as a standalone program, execute:

```
java org.apache.uima.ecore.UimaTypeSystem2Ecore <TypeSystem descriptor> <output file>
```

The input UIMA TypeSystem descriptor will be converted to an Ecore model file and written to the specified output file. You can then use the resulting Ecore model in EMF applications. The converted type system will include any `<import...>`ed TypeSystems; the fact that they were imported is currently not preserved.

To run either of these converters, your classpath will need to include the UIMA jar files as well as the following jar files from the EMF distribution: `common.jar`, `ecore.jar`, and `ecore.xmi.jar`.

Also, note that the `uima-core.jar` file contains the Ecore model file `uima.ecore`, which defines the built-in UIMA types. You may need to use this file from your EMF applications.

8.3. Using XMI CAS Serialization

The UIMA SDK provides XMI support through the following two classes:

XmiCasSerializer: can be run from within a UIMA application to write out a CAS to the standard XMI format. The XMI that is generated will be compliant with the Ecore model generated by `UimaTypeSystem2Ecore`. An EMF application could use this Ecore model to ingest and process the XMI produced by the `XmiCasSerializer`.

XmiCasDeserializer: can be run from within a UIMA application to read in an XMI document and populate a CAS. The XMI must conform to the Ecore model generated by `UimaTypeSystem2Ecore`.

Also, the `uimaj-examples` Eclipse project contains some example code that shows how to use the serializer and deserializer:

`org.apache.uima.examples.xmi.XmiWriterCasConsumer:` This is a CAS Consumer that writes each CAS to an output file in XMI format. It is analogous to the `XCasWriter` CAS Consumer that has existed in prior UIMA versions, except that it uses the XMI serialization format.

`org.apache.uima.examples.xmi.XmiCollectionReader:` This is a Collection Reader that reads a directory of XMI files and deserializes each of them into a CAS. For example, this would allow you to build a Collection Processing Engine that reads XMI files, which could contain some previous analysis results, and then do further analysis.

Finally, in under the folder `uimaj-examples/ecore_src` is the class `org.apache.uima.examples.xmi.XmiEcoreCasConsumer`, which writes each CAS to XMI format and also saves the Type System as an Ecore file. Since this uses the `UimaTypeSystem2Ecore` converter, to compile it you must add to your classpath the EMF jars `common.jar`, `ecore.jar`, and `ecore.xmi.jar` – see `ecore_src/readme.txt` for instructions.

8.3.1. Character Encoding Issues with XML Serialization

Note that not all valid Unicode characters are valid XML characters, at least not in XML 1.0. Moreover, it is possible to create characters in Java that are not even valid Unicode characters,

let alone XML characters. As UIMA character data is translated directly into XML character data on serialization, this may lead to issues. UIMA will therefore check that the character data that is being serialized is valid for the version of XML being used. If non-serializable character data is encountered during serialization, an exception is thrown and serialization fails (to avoid creating invalid XML data). UIMA does not simply replace the offending characters with some valid replacement character; the assumption being that most applications would not like to have their data modified automatically.

If you know you are going to use XML serialization, and you would like to avoid such issues on serialization, you should check any character data you create in UIMA ahead of time. Issues most often arise with the document text, as documents may originate at various sources, and may be of varying quality. So it's a particularly good idea to check the document text for characters that will cause issues for serialization.

UIMA provides a handful of functions to assist you in checking Java character data. Those methods are located in `org.apache.uima.internal.util.XMLUtils.checkForNonXmlCharacters()`, with several overloads. Please check the javadocs for further information.

Please note that these issues are not specific to XMI serialization, they apply to the older XCAS format in the same way.

